



**Pure Line®
Water Purifier
Model WE200**

Instruction Manual

First Edition

- Thank you for choosing the WE200 Pure Line water purifier by Yamato Scientific Co., Ltd.
- For proper equipment operation, please read this instruction manual thoroughly before use. Always keep equipment documentation safe and close at hand for convenient future reference.

Warning: Read instruction manual warnings and cautions carefully and completely before proceeding.

YAMATO SCIENTIFIC RUSSIA, INC.

Table of Contents

1. SAFETY PRECAUTIONS	1
Explanation of Symbols	1
Symbol Glossary	2
Warning and Cautions	3
2. PRE-OPERATION PROCEDURES	5
Installation	9
3. COMPONENT NAMES AND FUNCTIONS	18
Main Unit	18
Internal Plumbing System	19
Control Panel	23
4. OPERATION PROCEDURE	24
Prior Confirmation	24
Operation Procedure	24
Ion Exchange Water Sampling Procedure	25
Water Quality Index	26
Reverse Osmosis (RO) Membrane Flush	26
Water Purity Assessment Process	27
Water Quality Characteristics Data (reference)	28
Water Sample Size Data Based On Water Temperature (reference)	29
5. OPTIONAL ITEMS & MODIFICATIONS	30
Optional Components	30
Optional Power Cable Accessories	31
Optional Remote Sampling Terminal	33
Optional Remote Alert Terminal	33
6. MAINTENANCE PROCEDURES	34
Maintenance Guide	34
Ion Exchange Resin Cartridge Replacement	35
Pre-process Cartridge Replacement	35
Reverse Osmosis (RO) Membrane Replacement	35
Wear Item Replacement Alert Reset	36
Water Supply Hose Filter Maintenance	38
ELB Function Check	38
7. EXTENDED STORAGE & DISPOSAL	39
Disposal Considerations	40
8. TROUBLESHOOTING	41
Error Codes	41
Malfunctions	43
9. SERVICE & REPAIR	45
10. SPECIFICATIONS	46
11. WIRING DIAGRAM	47
Wiring Diagram Glossary	48
12. WEAR ITEMS	49
13. LIST OF HAZARDOUS SUBSTANCES	50
14. SETUP CHECKLIST	51

1. SAFETY PRECAUTIONS

Explanation of Symbols

A Word Regarding Symbols

Various symbols are provided throughout this text and on equipment to ensure safe operation. Failure to comprehend the operational hazards and risks associated with these symbols may lead to adverse results as explained below. Become thoroughly familiar with all symbols and their meanings by carefully reading the following text regarding symbols before proceeding

 **Warning** Signifies a situation which may result in serious injury or death (Note 1.)

 **Caution** Signifies a situation which may result in minor injury (Note 2) and/or property damage (Note 3.)

(Note 1) Serious injury is defined as bodily wounds, electrocution, bone breaks/fractures or poisoning, which may cause debilitation requiring extended hospitalization and/or outpatient treatment.

(Note 2) Minor injury is defined as bodily wounds or electrocution, which will not require extended hospitalization or outpatient treatment.

(Note 3) Property damage is defined as damage to facilities, equipment, buildings or other property.

Symbol Meanings

 Signifies warning or caution.
Specific explanation will follow symbol.

 Signifies restriction.
Specific restrictions will follow symbol.

 Signifies an action or actions which operator must undertake.
Specific instructions will follow symbol.

1. SAFETY PRECAUTIONS

Symbol Glossary

WARNING



General Warning



Danger!: High Voltage



Danger!: Extremely Hot



Danger!: Moving Parts



Danger!: Blast Hazard

CAUTION



General Caution



Caution: Shock Hazard!



Caution: Burn Hazard!



Caution: Do Not Heat Without Water!



Caution: May Leak Water!



Caution: Water Only



Caution: Toxic Chemicals

RESTRICTION



General Restriction



No Open Flame



Do Not Disassemble



Do Not Touch

ACTION



General Action Required



Connect Ground Wire



Level Installation

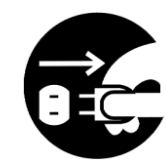

Disconnect Power



Inspect Regularly

1. SAFETY PRECAUTIONS

Warning and Cautions

Warning



NEVER operate equipment near combustible gases/fumes.

Do not install or operate WE200 unit near flammable or explosive gases/fumes. Unit is NOT fire or blast resistant. Negligent use could cause a fire/explosion. See "List of Hazardous Substances" (P.50).



ALWAYS ground equipment.

Always ground equipment properly to avoid electric shock.



Connect power cable securely to equipment.

Insert the power cable completely and securely into power socket located on the rear panel of main unit. A loose power cable connection may cause overheating or fire.



DO NOT operate equipment when abnormalities are detected.



If smoke or unusual odors begin emitting from unit, or if any other abnormalities are detected, terminate operation immediately, turn off main power switch (Earth Leakage Breaker - "ELB") and disconnect power cable. Continued operation under such conditions may result in fire or electric shock.



DO NOT operate equipment with bundled or tangled power cable.

Operating unit with the power cable bundled or otherwise tangled, may cause power cable to overheat and/or catch fire.



DO NOT damage power cable.

Damaging the power cable by forcibly bending, pulling or twisting may cause fire or electric shock to the operator.



NEVER disassemble or modify the equipment.

Attempting to dismantle or modify unit in any way, may cause malfunction, fire or electric shock.



DO NOT place items on equipment.

Do not place any objects on unit. Doing so may cause unit to become unstable and tip over, resulting in possible equipment damage or personal injury.



DO NOT step on or climb on top of equipment.

Do not attempt to climb onto unit or use as a substitute for a proper step ladder. Unit chassis is not designed to support bodily weight and damage may result. In addition, unit may become unstable and tip over or fall resulting in equipment damage, serious injury or death.

1. SAFETY PRECAUTIONS

Warning and Cautions

Warning

DO NOT adjust pressure reduction valve.

The pressure reduction valve has a default water sampling rate of approximately 0.8L/min (base water pressure: 0.30MPa, pressure reduction valve: 0.20MPa, throttle valve: 0.60MPa, water temperature: 20°C without membrane filter), as set at factory before shipping. Do not attempt to adjust it.
Altering any of the factory settings may cause unit to leak or have decreased flow rate.

DO NOT turn ELB OFF.

Water is routinely flushed through the system, even while water samples are not being drawn. Be advised that if the ELB is turned "OFF" for an extended period of time, water retained in the system cannot be flushed through, resulting in accelerated deterioration of the reverse osmosis (RO) membrane degraded water purity.

DO NOT shut off water supply.

Water is routinely flushed through the system, to protect the RO membrane and maintain water quality. The water supply tap should normally be left open to keep the flush function enabled. Be advised that the flush function produces normal water discharge from system. Prepare accordingly.

Caution

DO NOT operate equipment during thunderstorms.



In the event of a thunderstorm, terminate operation and turn off main power switch (ELB) immediately. A direct lightning strike may cause damage to equipment, or result in fire or electric shock.

Power loss.

Although unit naturally stops when a power failure occurs, turn main power switch (ELB) "OFF" for safety. Follow procedures under "Turning power ON" (P.24) after power is restored.

2. PRE-OPERATION PROCEDURES

Installation Precautions and Preparations



Warning

1. Ground wire **MUST** be connected properly.



- Ground wire must be connected to a proper grounding line or terminal in order to prevent electric shock.
- Never connect ground wire to gas lines or water pipes.
- Never connect ground wire to telephone grounding lines or to lightning conductor rods. Doing so may result in fire or electrical shock.
- Never insert multiple plugs into a single outlet. Doing so may result in power cable overheating, fire or drop in voltage.

Connect to grounded outlet

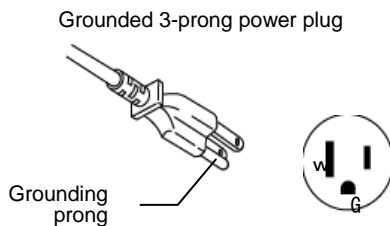

Use grounded adaptor for ungrounded outlets

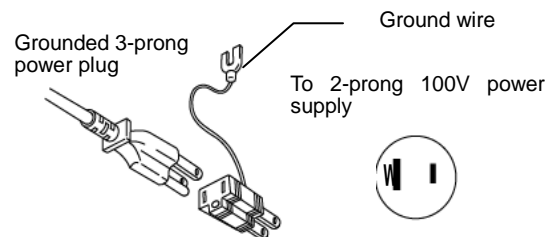

When no ground terminal is found:

- Grounding to Electrical Equipment Technical Standards, Section 19, class D (Grounding Resistance Max. 100Ω) is required in Japan. Contact a local dealer, electrician, or Yamato Sales office for location-specific electrical requirements.

Ground adaptor

- Insert grounded plug into ground adaptor. Connect grounding wire (green) from ground adaptor to a ground terminal.

2. Choose an appropriate installation site.



DO NOT install unit:

- where flammable or corrosive gases/fumes will be generated.
- where ambient temperature will exceed 35°C, will fall below 5°C or will fluctuate.
- in excessively humid or dusty locations.
- where there is constant vibration.
- where power supply is erratic.
- in direct sunlight or outdoors.
- on uneven or unstable surfaces
- where base water pressure is higher than 0.50MPa or lower than 0.13MPa
- where water temperature is 10°C or lower
- where temperature is 30°C or higher



Install WE200 unit in a location with sufficient space, as specified on the right.

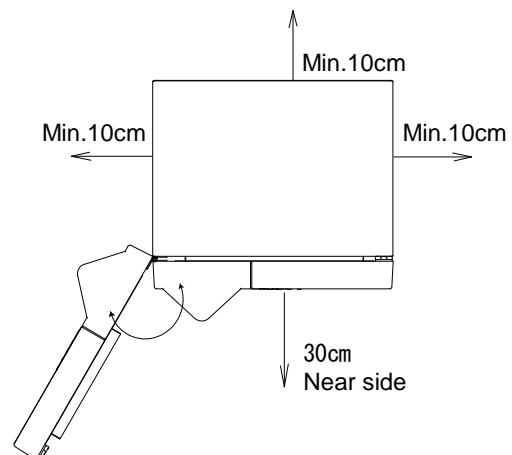

2. PRE-OPERATION PROCEDURES

Installation Precautions

3. Install in a location free of flammables and explosives.



- Never install near flammables or explosives. This unit is NOT fire or blast resistant. Simply switching the main power switch (ELB) "ON" or "OFF" can produce a spark, which can then be relayed during operation, causing a fire or explosion when near flammable or explosive fluids, chemicals or gases/fumes.
- See "List of Hazardous Substances" (P.50) for more details on flammable and explosive gases.

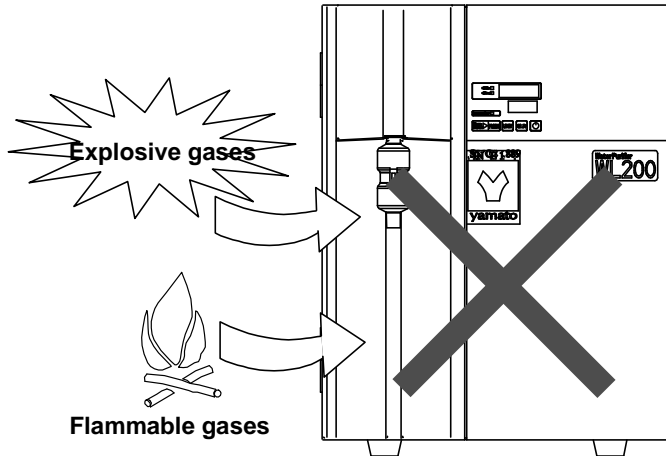

4. Install on a level surface.



- Install unit on level and even surface. Failure to do so may cause abnormal vibrations or noise, resulting in possible complications and/or malfunction.

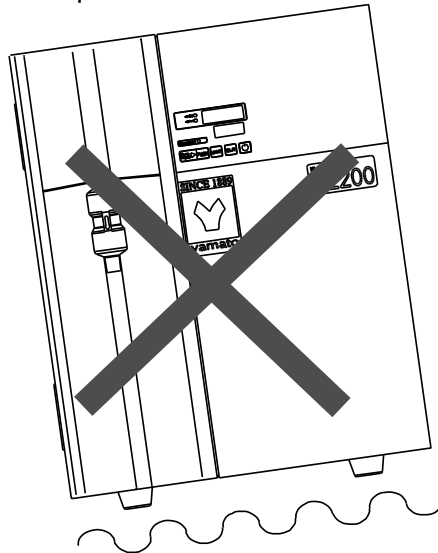

5. Connect power cable to proper outlet.



- Use an outlet which conforms to proper electrical capacity rating (15A or greater).
- If capacity is inadequate, sample sizes will be too small, or performance will be impaired due to voltage drop. Connect to a power supply with stable power and proper rating.

Electrical capacity: WE200 rated voltage: Single phase AC100-240V

Rated frequency: 50/60Hz

Rated maximum current: 1.5A

- Using a cord reel extension cord may cause voltage to drop.
- Inserting multiple plugs into a single outlet (with adapter) may cause voltage drop or fire.

2. PRE-OPERATION PROCEDURES

Installation Precautions

6. Power cable connection.



- Insert the supplied power cord securely into socket on rear of main unit. Be sure that the ELB on the right panel is “OFF (o)” before connecting power cable plug to facility outlet. Be sure unit is grounded properly



- If a power cable other than the one supplied is to be used, be sure that it facilitates proper grounding and that it conforms to power supply and to equipment power ratings.

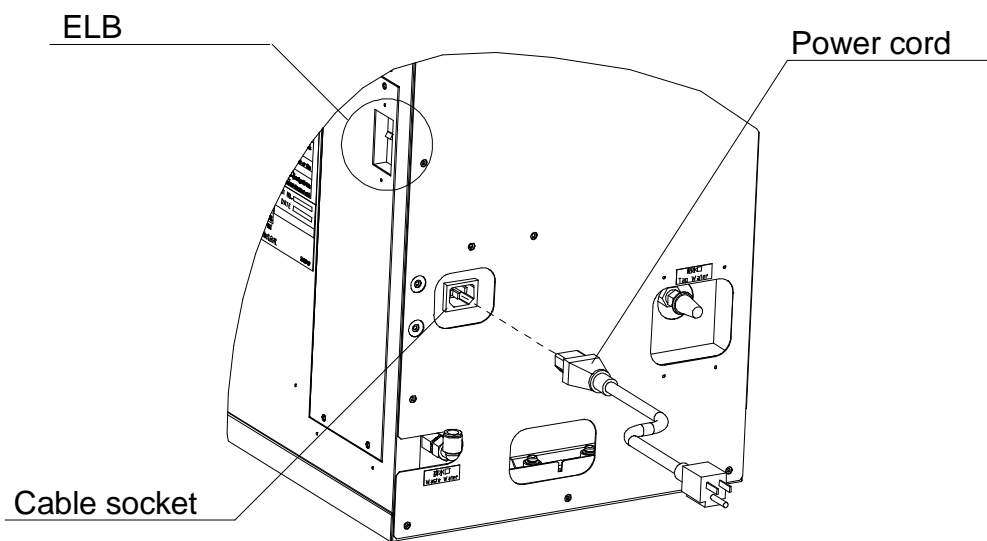

7. Handle power cable with care.



- Never operate this unit with power cable bundled or tangled; and do not modify, bend, forcibly twist or pull on power cable. Doing so may cause fire and/or electrical shock.



- Do not risk damage to power cable by positioning it under desks or chairs, or by pinching it between objects. Doing so may cause fire and/or electrical shock.



- Do not place power cable near kerosene/electric heaters or other heat-generating devices. Doing so may cause power cable insulation to overheat, melt and/or catch fire, which may result in electric shock.

- Turn off main power switch (ELB) immediately and disconnect from facility terminal or outlet, if power cable becomes partially severed or damaged in any way.

Failure to do so may result in fire or electric shock.

Contact a local dealer or Yamato sales office for information about replacing power cable if it becomes damaged.

- Always connect power cable to appropriate facility outlet or terminal.

2. PRE-OPERATION PROCEDURES

Installation Precautions

8. Base water.



- Use tap water as base.
- Never use chemicals or lubricants. Malfunction may result and water quality will be compromised.
- Verify that base water does not contain rust or other contaminants. Contaminated base water not only prevents specification-quality water but may also cause malfunction.
- Give particular care to base water quality.

9. Keep base water pressure within specified range.



- Keep working base water pressure within 0.13MPa~0.50MPa (1.3kgf/cm² ~ 4.9kgf/cm²), including during evening and night time.
Base water pressures below 0.20MPa (2.0kgf/cm²), however, may result in water samples of 0.5ℓ/min or less.
- Working base water pressure range does not change with optional “Water Supply Nozzle Unit” (P.30).

2. PRE-OPERATION PROCEDURES

Installation

1. Connect water supply hose securely.



- Use the included water supply hose kit (connector, water supply hose). Place main unit on a level and stable surface, near a water tap and sink.
- If hose is not connected securely, water supply hose or connector may slip off and cause water to spray or otherwise leak.
- Do not over tighten the supply hose connector fitting, or it may be damaged.

2. Connect tap.



1. Slide the socket sleeve ③ down in the direction of arrow. Connector fitting and water supply hose can be disconnected.
2. Loosen the plug ② from the ring ①.
3. Tighten the 4 mounting screws ⑤ equally, while inserting the tap nozzle firmly into the nozzle ring ①, keeping the gasket ⑥ even on the tip of the tap nozzle. If a chemical tap is to be used, adjust the position of nozzle ring so that the mounting screws are in one of the grooves on the tap nozzle, as shown, when tightened.
4. Turn plug ② clockwise to tighten securely. This will allow tap nozzle and connector fitting to be sealed by the gasket ⑥.

* When the socket is removed, a valve inside of connector plug stops water flow.

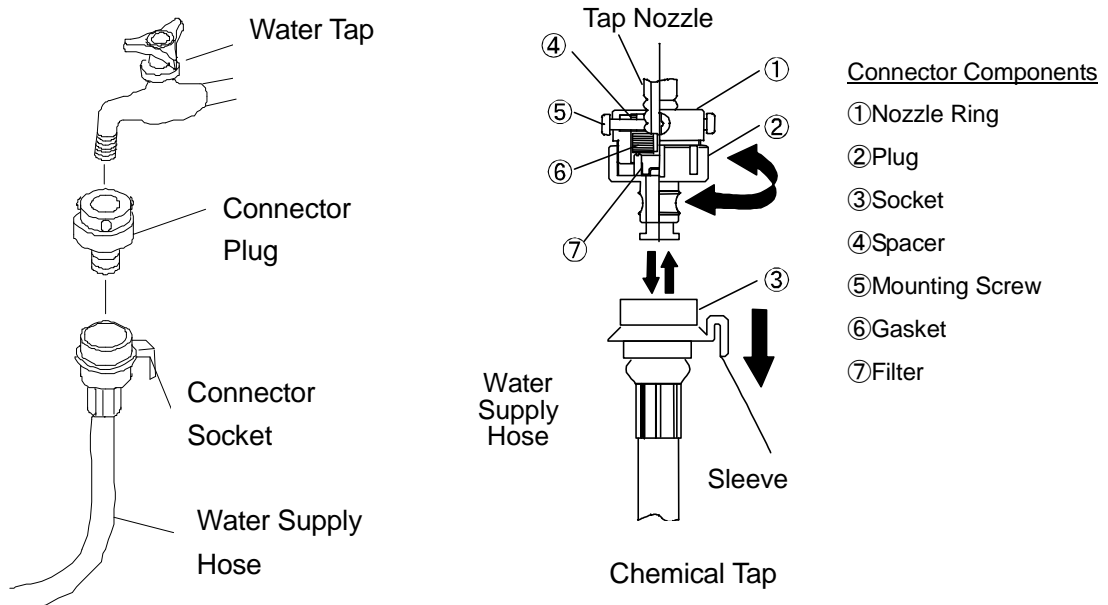

2. PRE-OPERATION PROCEDURES

Installation

3. Make water supply connection.



- (1) Remove rubber cap from connector plug ⑧.
 - (2) Insert connector plug ⑧ securely into connector socket ⑨ with the sleeve held down in direction of arrow. Sleeve returns to the original position when released, if connection is secure.
- ※ The connector socket contains a valve, which opens only when socket is inserted. When socket is removed, water cannot enter.

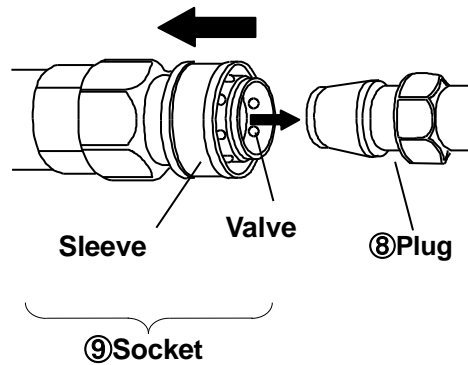

4. Connect water supply hose only to tap equipped with sink, where possible.



If water supply hose is connected to a water tap without sink facilities, flooding may occur if water supply hose is unintentionally disconnected or damaged. Connecting to a water tap having a sink is therefore preferable.

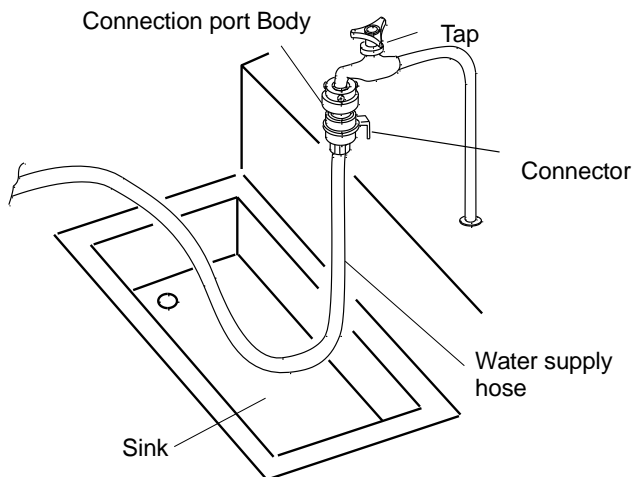

5. If no sink is available.



- Use optional Water Supply Port Unit (found on P.30) designed to provide a more secure connection under fluctuating water pressure than the standard connector kit and hose.

6. If no tap is available.



- Use one of the appropriate optional Water Supply Port Coupler Joints on P.30.

2. PRE-OPERATION PROCEDURES

Installation

7. Install the ion exchange resin cartridge.



● Turn power off and close water tap before installing or replacing the ion exchange resin cartridge.

● Install procedure:

- (1) Remove rubber cap from ion exchange resin cartridge.
- (2) Install ion exchange resin cartridge securely into the resin drum installation plate, inside the WE200 unit. (See Figure 1.)

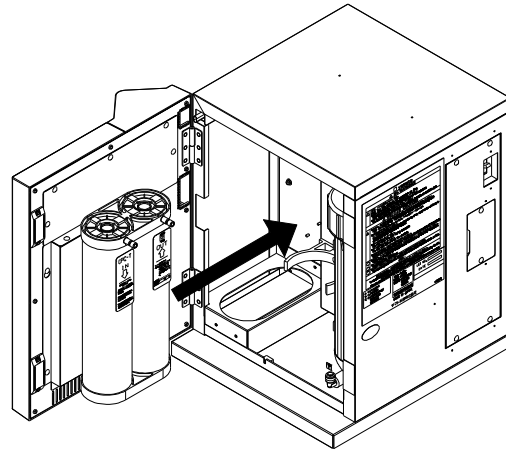

Figure 1

- (3) Push quick coupler from "IE OUT" tube onto the cartridge "OUT" coupler fitting, until it clicks. (See Figure 2)
- (4) Push quick coupler from "IE IN" tube onto the cartridge "IN" coupler fitting, until it clicks. (See Figure 2)

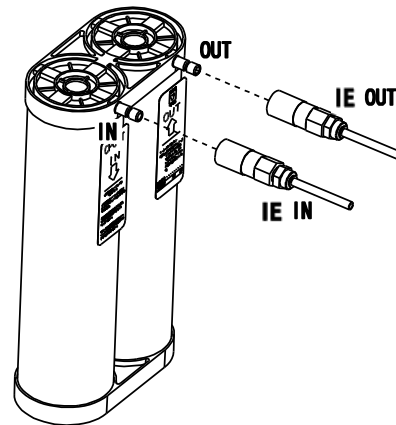

Figure 2

● Removal procedure:

- (1) Remove quick coupler by pushing the black part of the coupler casing toward the cartridge while pulling the coupler off. (See Figure 3)
- (2) Remove the coupler from the IN side first, followed by the OUT side.

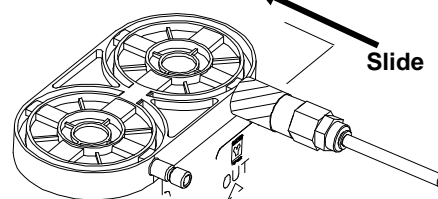

Figure 3

- ※ Quick couplers may be stiff with first few uses and cartridge coupler fittings may break off, if too much force is applied. If installing the couplers is too difficult with ion exchange cartridge installed, remove it from the main unit and connect the hoses, first. Be sure not to kink the plastic tubes while using this method.
- ※ Once hoses are connected, give each coupler a gentle tug to verify that they are securely in place.
- ※ When removing quick couplers, water may drip from the ion exchange resin cartridge fitting. Be careful not to let water get on the leak sensor.
- ※ **Be sure not to cross the hoses (e.g. connect IN hose to OUT tip and vice versa) when replacing the ion exchange cartridge. Malfunction may result.**

2. PRE-OPERATION PROCEDURES

Installation

8. Install the pre-process cartridge.



● Turn power off and close water tap before installing or replacing the pre-process cartridge.

● Install procedure:

- (1) Remove rubber cap from the process cartridge.
- (2) Place pre-process cartridge into designated bracket, inside the WE200 unit. (See Figure 4)
- (3) Connect the pre-process coupler, "PWF OUT" to the "OUT" fitting on the pre-process cartridge, while sliding the light blue coupler tip back. (See Figure 5 & 6)
- (4) Connect the pre-process coupler, "PWF IN" to the "IN" fitting on the pre-process cartridge, while sliding the light blue coupler tip back. (See Figure 5 & 6)

Pre-process cartridge bracket

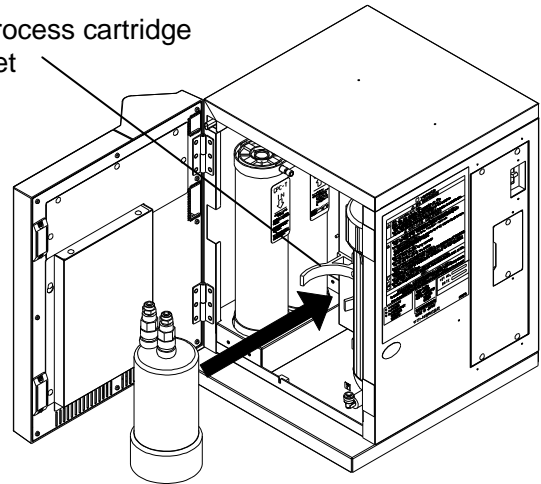

Figure 4

● Removal procedure:

- (1) Remove the pre-process coupler simply by holding it by the light blue tip and pulling upward. (See Figure 6.)
- (2) Remove from the "IN" side first, followed by the "OUT" side.

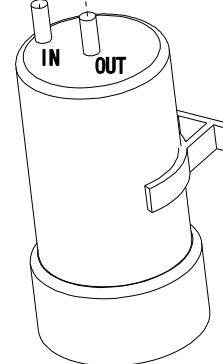
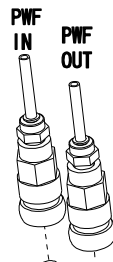

Figure 5

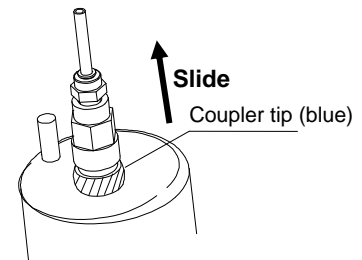

Figure 6

※ Once pre-process hoses are installed, give each coupler a gentle tug to verify that they are securely in place..

※ When removing pre-process couplers, water may drip from the pre-process cartridge fittings. Be careful not to let water get on the leak sensor.

2. PRE-OPERATION PROCEDURES

Installation

9. Install the membrane filter.



- Install the membrane filter as follows:
- Unless watertight connection is made, threaded portion may leak fluid which could mix with and contaminate pure water samples. Always ensure a secure, watertight connection.

- (1) From the included items, take out two membrane filters and the roll of Teflon thread seal tape.
- (2) Observe the direction of the arrow on the membrane filter. Apply thread seal tape by winding it clockwise around the threads, as shown, for two to three turns, while pulling on tape to stretch it slightly. Begin wrapping at third thread from the tip, so that first two threads remain exposed. Cut remaining tape away.

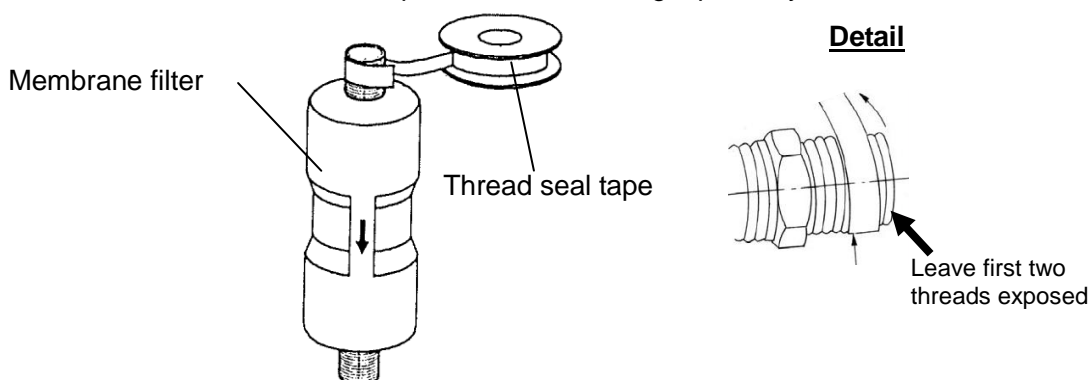

- (3) Screw the membrane filter into receptacle on front of unit, so that the side with the thread seal tape is up. Exercise care not to crush threads. Draw a pure water sample and check for leaks from membrane filter. If any leaking is found, screw membrane filter in further. The reference number of turns to tighten is two and a half to three.

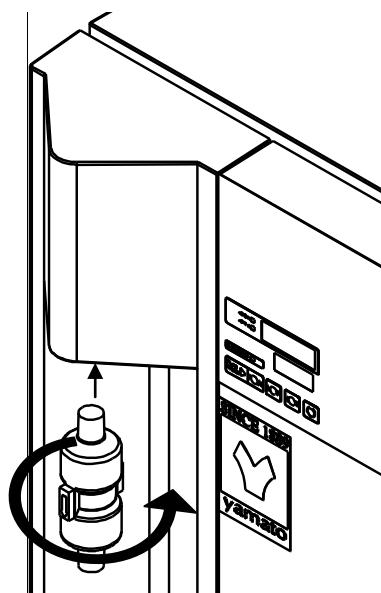

- ※ Store the remaining thread seal tape in a safe and convenient location. It is used for every membrane filter change.

2. PRE-OPERATION PROCEDURES

Installation

10. Connect drain hose.



- Follow the procedures below to connect drain hose.
- Be sure to connect the drain hose securely, or water may leak from connection joint.

(1) While holding the quick coupler by hand, push the drain hose completely and evenly into the drain port on the rear of unit.

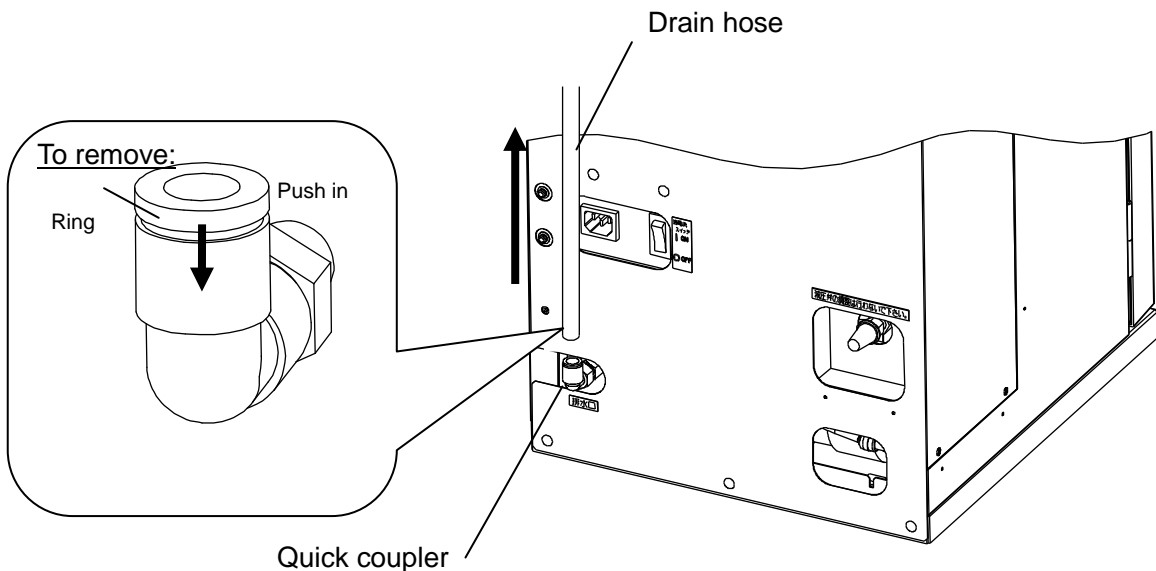

- ※ To remove the drain hose, pull out while pushing in the quick coupler ring.
- ※ Be sure to put drain hose into sink, once it is removed.

11. Exercise care in routing drain hose.



- If drain hose is bent, kinked or otherwise obstructed, drainage cannot be expended properly. Drainage back-up or damage to the cooling hose may result.
- Place the end of the drain hose so that it is lower than the drain port on unit, and avoid drain systems which allow fluid to remain in pipe or to puddle near the outlet, causing drainage resistance or obstructions.

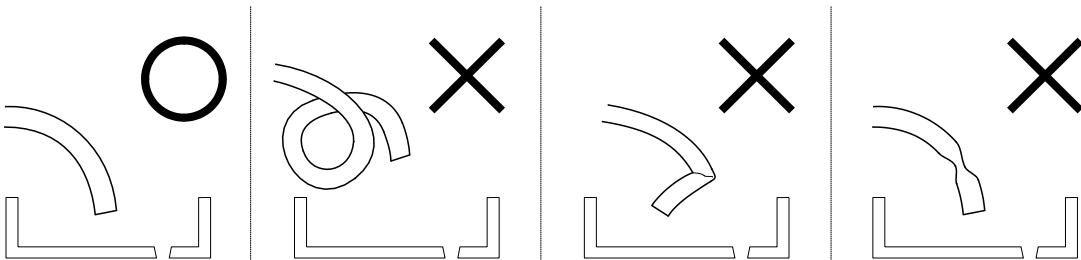

12. Confirm stability.



Unit may tip over or fall in the event of an earthquake or other similar incident, resulting in injury or death. As an added safety precaution, be sure to implement measures to properly stabilize unit.

2. PRE-OPERATION PROCEDURES

Installation

13. Install the reverse osmosis (RO) membrane.



- Turn power off and close water tap before installing or replacing the reverse osmosis (RO) membrane.
- WE200 unit is shipped with an RO membrane installed. Review the following when replacing.

● Install procedure:

- (1) Place RO membrane into designated brackets as shown in Figure 7.
- (2) Push tube marked, "RO IN" evenly into the upper coupler on RO membrane.
- (3) Push tube marked, "RO Left" evenly into lower left coupler on RO membrane.
- (4) Push tube marked, "RO Right" evenly into lower right coupler on RO membrane.

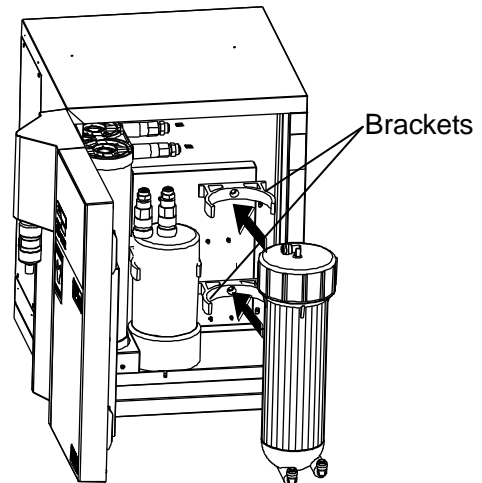

Figure 7

● Removal procedure:

- (1) Tubes are easily removed from couplers, simply by pushing the coupler collet in and pulling tube out. (See Figure 9.)

※ Tubes are more easily removed by pushing entire collet in, rather than only a portion of it.

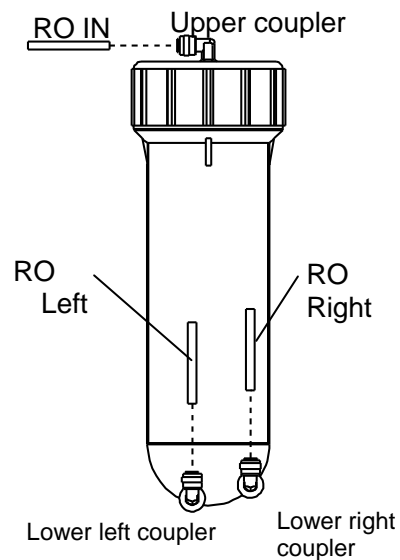

Figure 08

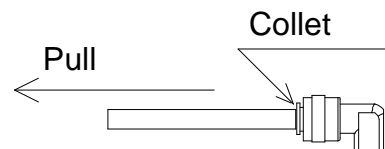

Figure 09

- ※ Once all three tubes have been connected, give each a gentle tug to verify that they are connected securely.
- ※ When removing tubes, water may drip from RO membrane couplers. Be careful not to let water get on the leak sensor.

2. PRE-OPERATION PROCEDURES

Installation

14. Run initial wash for reverse osmosis membrane (after unit delivery and after each time membrane is replaced)

Initial wash selector switch

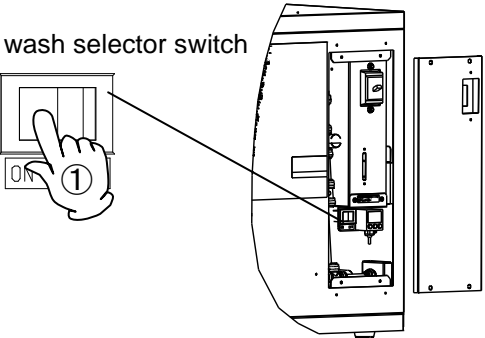

×10⁻⁴S/m rO

×10⁴Ω·m FLSh

In-operation

Pure Water ▶ **PUSH** UNIT CLR

20.0

×10⁻⁴S/m cLEn

×10⁴Ω·m

In-operation

Pure Water ▶ **PUSH** UNIT CLR

0.0

×10⁻⁴S/m End

×10⁴Ω·m

In-operation

Pure Water ▶ **PUSH** UNIT CLR

End

POWER

- ① Remove the four retaining screws from the right cover of main unit and remove cover. Turn the initial wash selector switch to "ON".
- ② Turn ELB "ON" (|), then press and hold **PUSH**.
 - rO appears in water quality display.
 - FLSh flashes in information display.
- ③ Press and hold **PUSH** again and initial wash begins. ※ Remaining water volume (in ℓ) used for initial wash will appear and be counted down.
 - 20.0 appears in water quality display
 - cLEn flashes in information display
- ④ A buzzer sounds when initial wash has finished.
 - 0.0 appears in water quality display
 - End flashes in information display
- ⑤ Be sure to turn the initial wash selector to "OFF".
- ※ Normal operation cannot be performed with the initial wash selector switch "ON".
- ⑥ Press **POWER** to complete the process. Replace the cover.

※ Press and hold **CLR** to stop initial wash while in progress. In this case, mode will skip to ⑥.

※ If a power loss occurs during initial wash, mode shifts to ② when power is restored. Start initial wash again, from the beginning.

2. PRE-OPERATION PROCEDURES

Installation

15. Calibrate pressure for reverse osmosis membrane.



- Calibrate pressure for the RO membrane ONLY while taking a water sample.
- This process must be conducted when WE200 is first installed and each time RO membrane is replaced.

● Pressure calibration procedure:

- (1) Remove the right cover of main unit and confirm the location of pressure calibration valve and pressure gauge. (See Figure 10.)
- (2) Turn ELB "ON" (|) and begin water sampling process. (See P.25)
- (3) Press and hold **UNIT** while drawing water sample to display the current water temperature. (See Figure 11.)
- (4) Using the temperature shown in the information display, refer to Table 1 for a corresponding pressure. Calibrate to the appropriate pressure by turning the pressure adjustment valve.

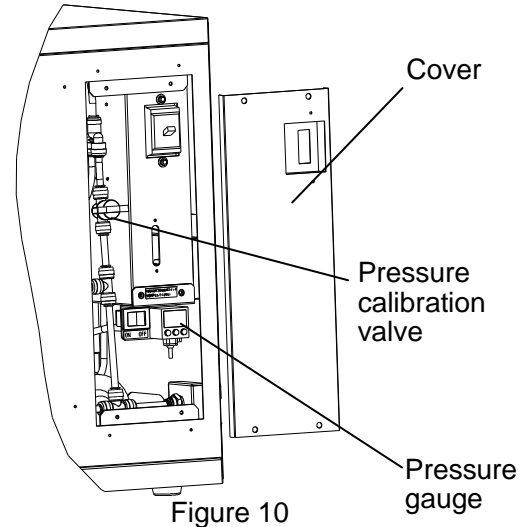

Figure 10

Example:

If information display shows "20" (20°C), corresponding pressure is 0.60MPa.

- (5) When calibration is completed, close the right cover on main unit.

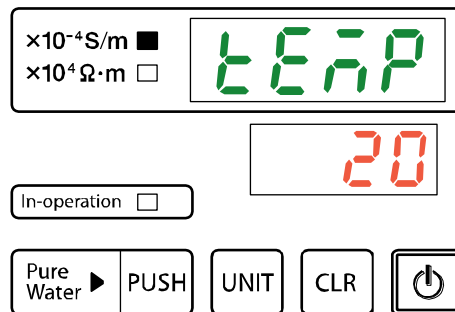

Figure 11

Table 1

Water temperature (°C)	Pressure (MPa)	Water temperature (°C)	Pressure (MPa)
10	0.69	21	0.59
11	0.68	22	0.58
12	0.67	23	0.57
13	0.66	24	0.56
14	0.65	25	0.55
15	0.64	26	0.54
16	0.63	27	0.53
17	0.63	28	0.52
18	0.62	29	0.51
19	0.61	30	0.50
20	0.60		

- ※ If pressure is not calibrated according to the procedure above, specified sample size cannot be dispensed. If incorrect sample size is suspected after calibrating pressure, call for service.
- ※ Replacing the reverse osmosis membrane, hosepipes and the pressurization pump at the same time, every two years, is recommended. Contact nearest sales office or dealer for assistance.

3. COMPONENT NAMES AND FUNCTIONS

Main Unit

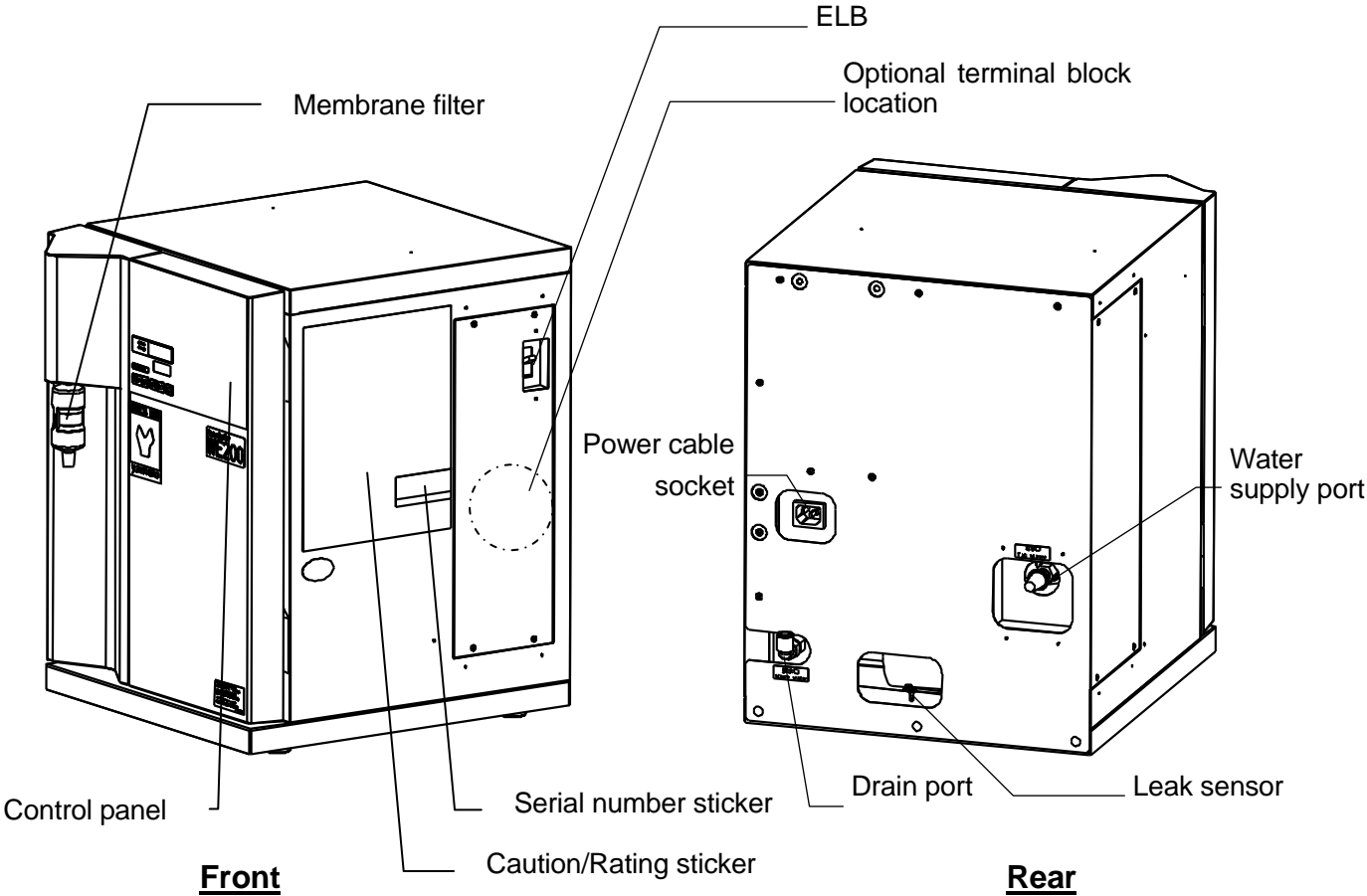
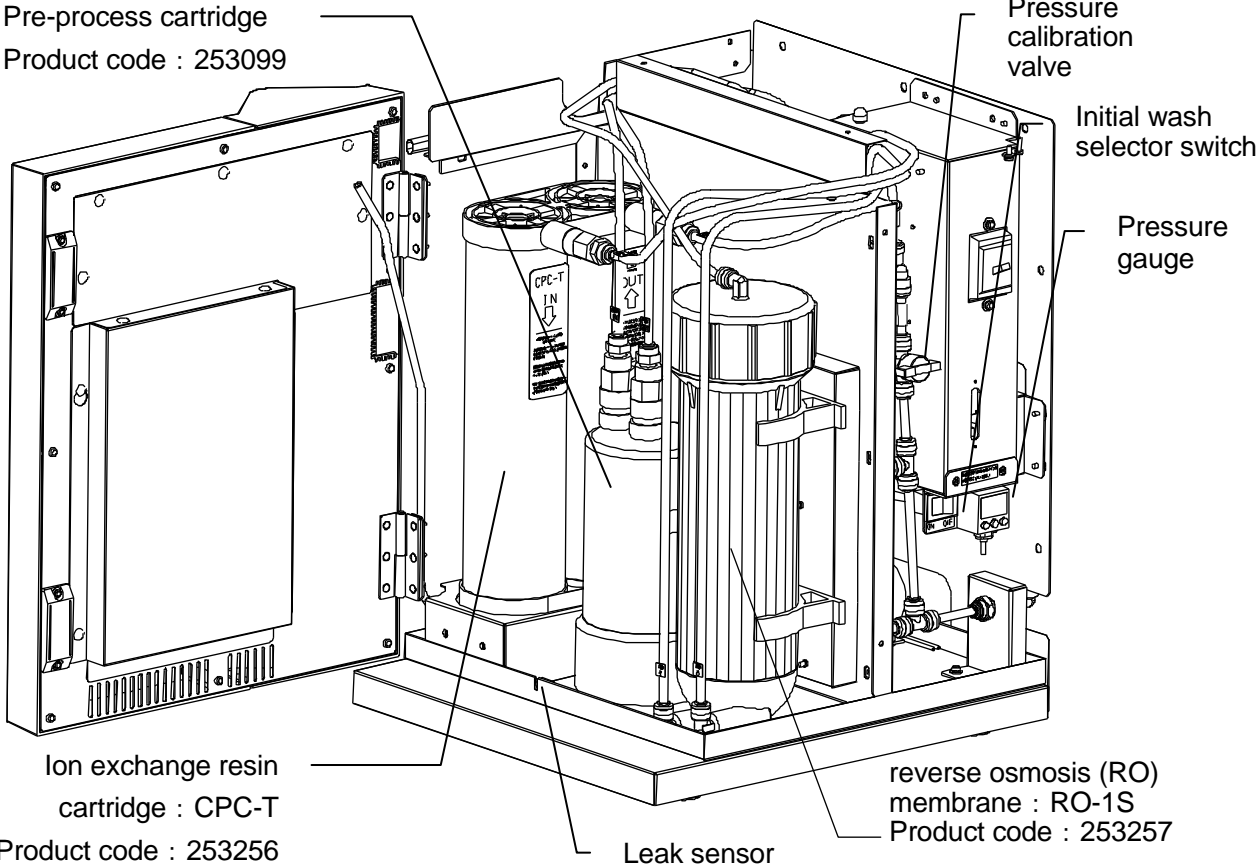

3. COMPONENT NAMES AND FUNCTIONS

Internal Plumbing System

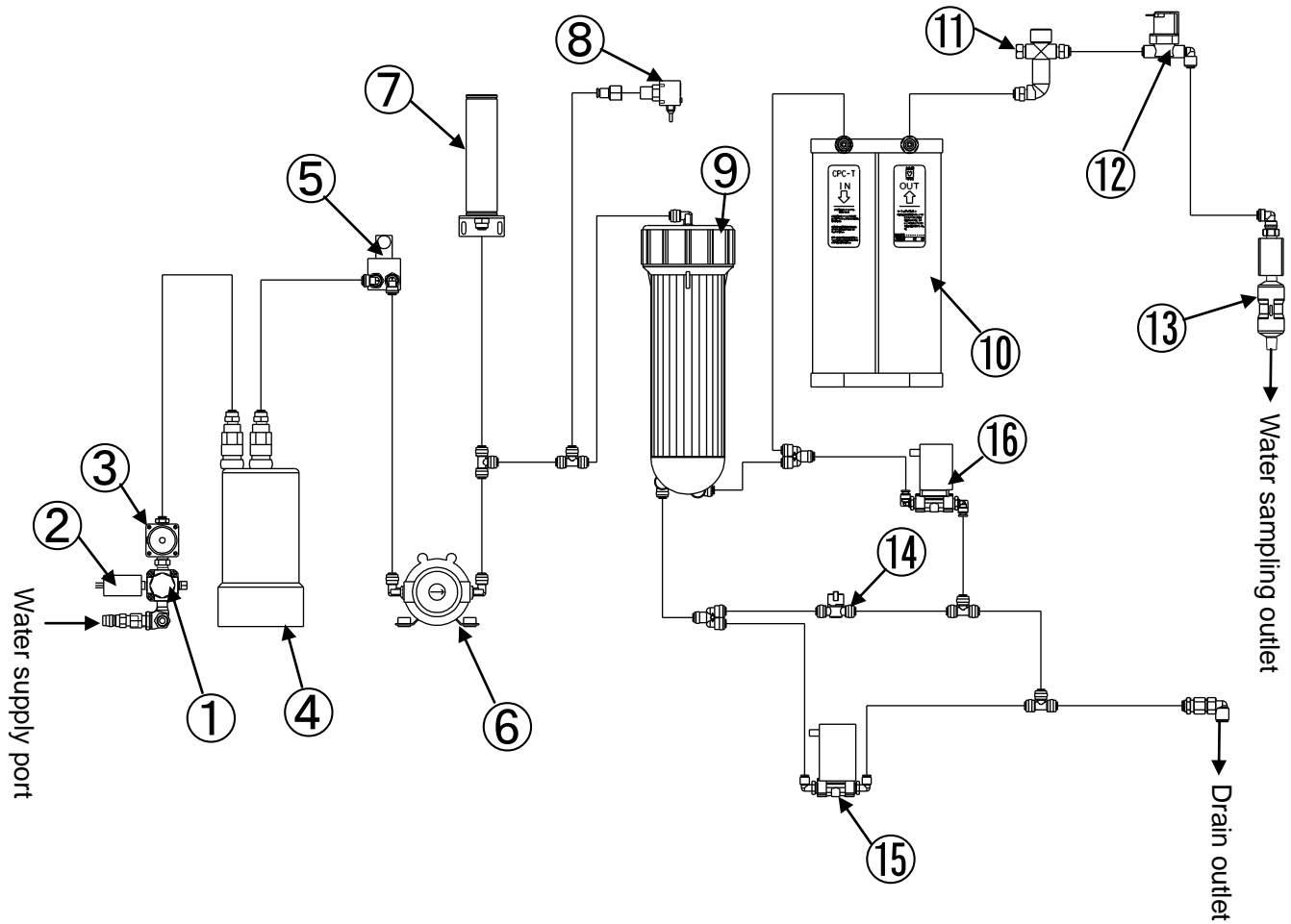

- | | |
|--------------------------------|---|
| 1. Pressure reduction valve | 9. reverse osmosis (RO) membrane |
| 2. Pressure switch | 10. Ion exchange resin cartridge CPC-T |
| 3. Water supply solenoid valve | 11. Water quality sensor |
| 4. Pre-process cartridge | 12. Water sampling solenoid valve |
| 5. Flow sensor | 13. Membrane filter |
| 6. Pressurization pump | 14. Pressure calibration valve |
| 7. Damper tank | 15. Concentrated water drain solenoid valve |
| 8. Pressure gauge | 16. Filtered water drain solenoid valve |

3. COMPONENT NAMES AND FUNCTIONS

Ion Exchange Water Sampling Process

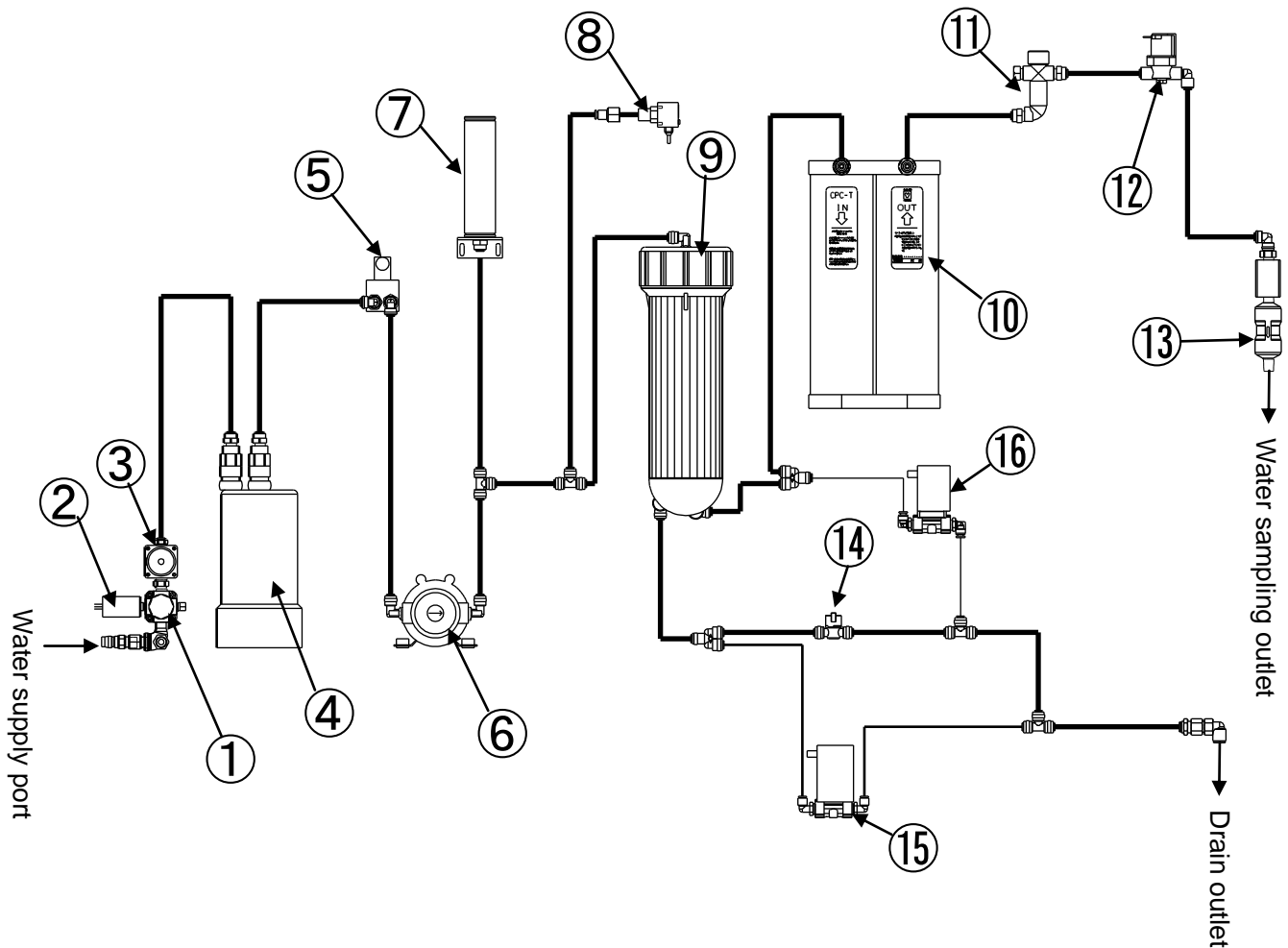

- Ion exchange water sampling process route is as follows: ①pressure reduction valve, ③water supply solenoid valve, ④pre-process cartridge, ⑤flow sensor, ⑥pressurizing pump, ⑨reverse osmosis (RO) membrane, ⑩ion exchange resin cartridge, ⑪water quality sensor, ⑫water sampling solenoid valve, ⑬membrane filter (water sample outlet).
- Water concentrated in the reverse osmosis (RO) membrane is drained through the ⑨reverse osmosis (RO) membrane and ⑭pressure calibration valve.
- Draining is also done during water sampling process for water concentrated in the reverse osmosis (RO) membrane.

3. COMPONENT NAMES AND FUNCTIONS

Initial Wash for RO Membrane

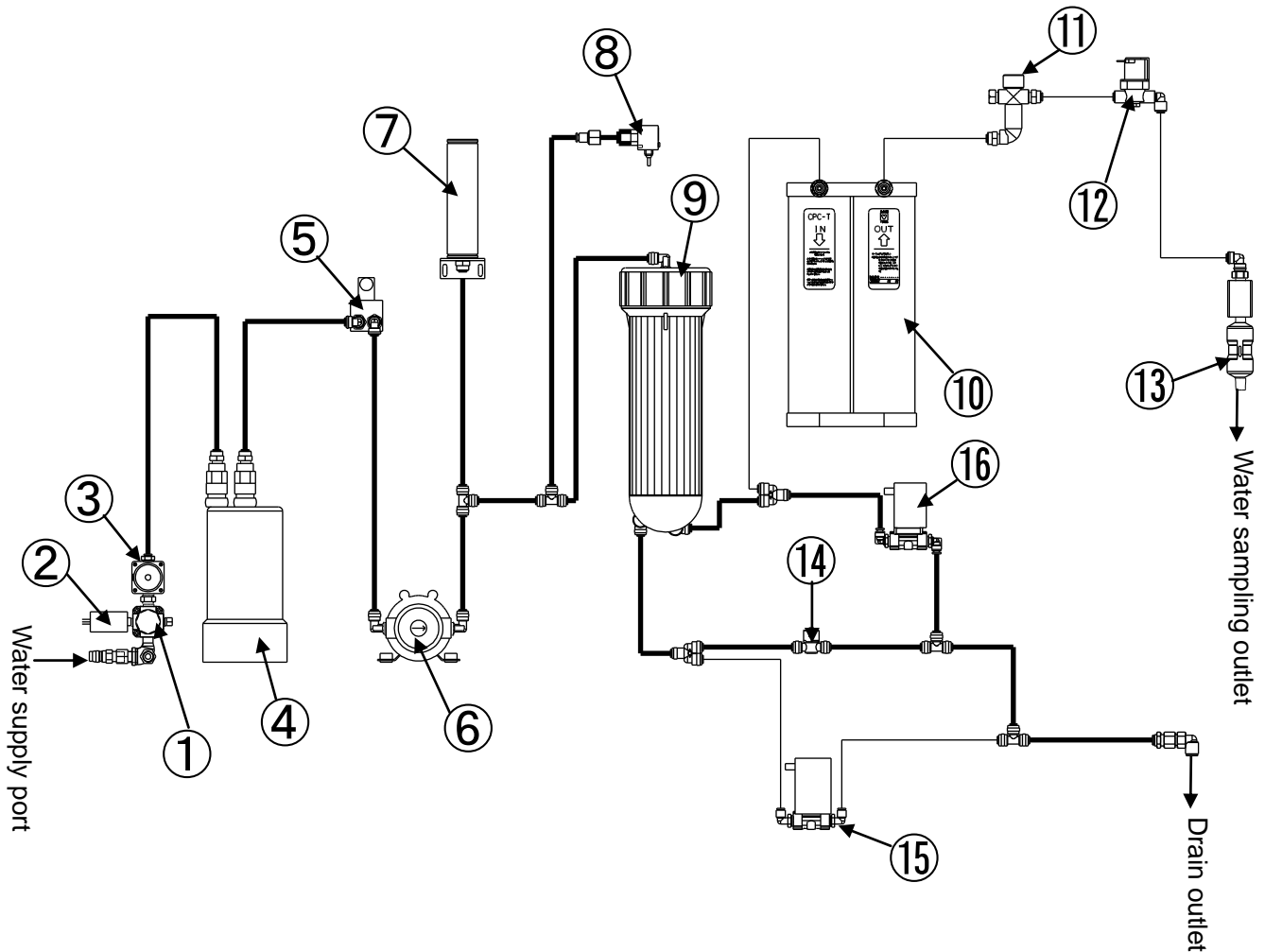

- Initial wash is necessary for stable quality in the pure water sampling process, by removing filler from new RO membrane cartridges. Be sure to conduct this process on new installation and each time the RO membrane is replaced.
- To run an initial wash, refer to the procedure on P.16.
- In an initial wash, water is routed via ①pressure reduction valve, ③water supply solenoid valve, ④pre-process cartridge, ⑤flow sensor, ⑥pressurization pump, ⑨reverse osmosis (RO) membrane, ⑭pressure calibration valve, and ⑮filtered water drain solenoid valve. Initial wash stops automatically when 20L of water is flushed through the reverse osmosis (RO) membrane. (See P.16.)

3. COMPONENT NAMES AND FUNCTIONS

System Flush Function

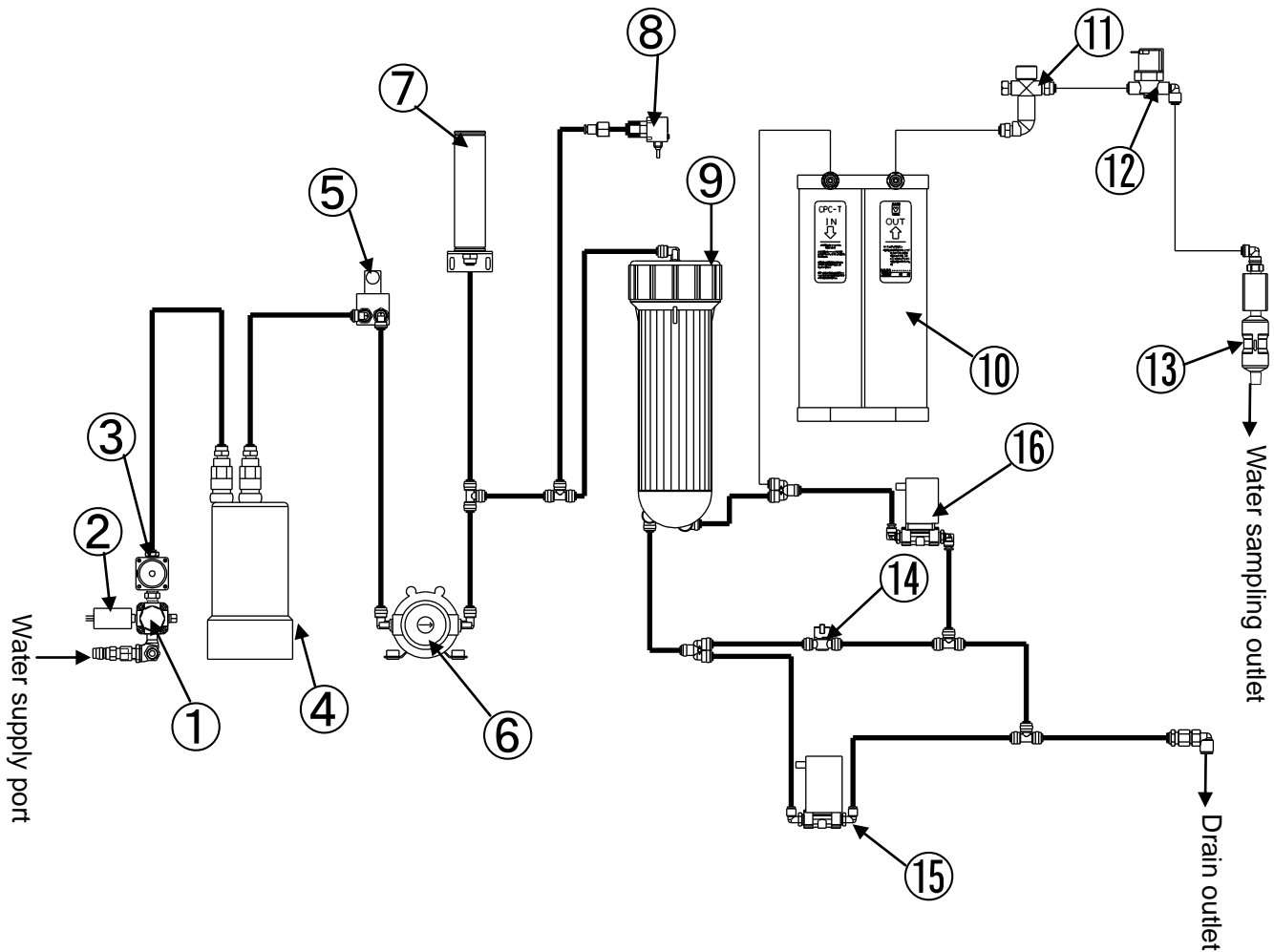

- The flush function protects the RO membrane and prevents contamination of water remaining in the pipes by removing foreign matter in the reverse osmosis (RO) membrane. This function is automatic. Thus, keeping water supply/drainage enabled and leaving ELB “ON” (|) is required.
- Flushing, washing and drainage is routed via ① pressure reduction valve, ③ water supply solenoid valve, ④ pre-process cartridge, ⑤ flow sensor, ⑥ pressurizing pump, ⑨ reverse osmosis (RO) membrane, ⑮ condensed water drain solenoid valve, ⑭ pressure adjusting valve throttle valve, and ⑯ filtered water drain solenoid valve. Flushing stops automatically after approximately one minute.
- The system is flushed out automatically, six hours after the last operation session and every 24 hours thereafter.

3. COMPONENT NAMES AND FUNCTIONS

Control Panel

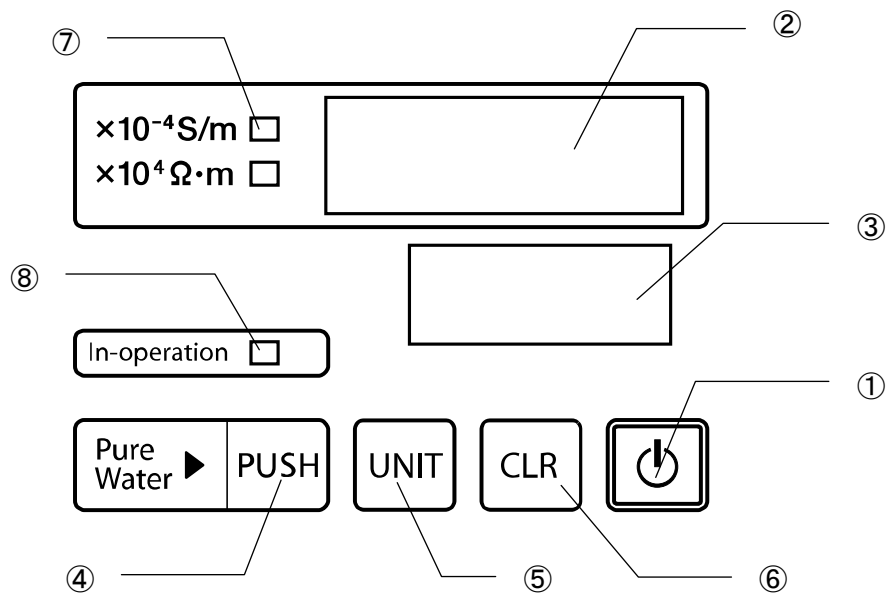

No.	Name	Function
①	Power key	power ON/OFF
②	Water quality display	Displays quality of ion exchange water
③	Information display	Displays errors, wear item replacement alerts and operation status.
④	PUSH key	Start/Stop ion exchange water sample
⑤	UNIT key	Toggles between water quality indexes ($x10^{-4}S/m \leftrightarrow x10^4\Omega \cdot m$)
⑥	CLR key	Utilized for replacing wear items.
⑦	Water quality index lamps	Illuminates to show which water quality factor is currently ON
⑧	In-operation lamp	Illuminates when ion exchange water is being sampled

List of display characters

0	1	2	3	4	5	6	7	8	9
A	B	C	D	E	F	G	H	I	J
K	L	M	N	O	P	Q	R	S	T
U	V	W	X	Y	Z	-	Blank		

4. OPERATION PROCEDURE

Prior Confirmation

Confirm the following before operating WE200.

(1) Inspect water supply and drainage

- Confirm that water supply hose is securely connected.
- Confirm that drain hose runs to sink unobstructed and has no bends or kinks.
- Open water tap.
- Confirm that there are no leaks at connection joint in water supply hose.

(2) Inspect power supply

- Confirm that the power cable has been connected to proper outlet.
- Confirm that the power cable has been securely and completely inserted into the cable socket on main unit.

Operation Procedure

To begin operation, follow the procedures below.

Turning power ON

ELB

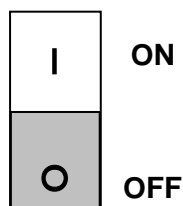

Turn the ELB, located on the right panel of main unit, to “ON (|)”.

Control panel (initial display)

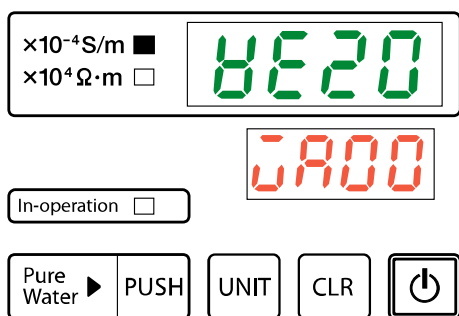

- Initial display will appear for approximately four seconds. Then, only water quality lamp illuminates.

4. OPERATION PROCEDURE

Ion Exchange Water Sampling Procedure

Sampling ion exchange water

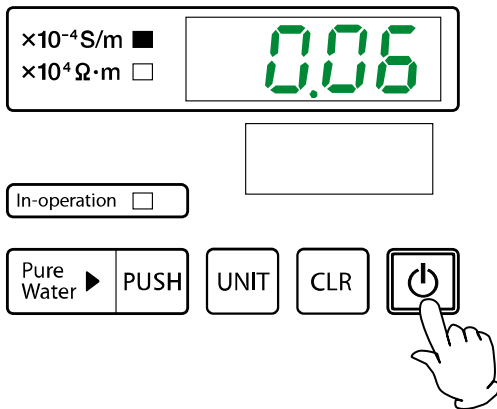

① Press **POWER**.

- Water quality appears in the water quality display

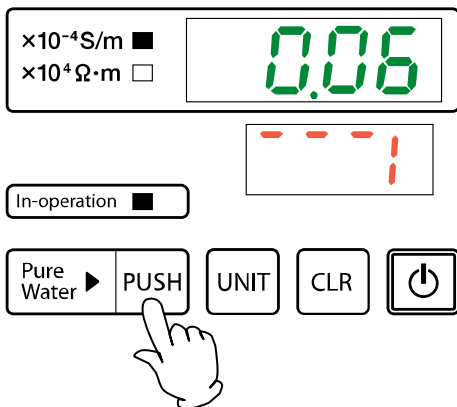

② Ion exchange water may be sampled by pressing **PUSH**. Sample will not stop dispensing after releasing key.

- “In-operation” lamp illuminates and information display shows sample dispensing progress.

Sample dispensing progress:

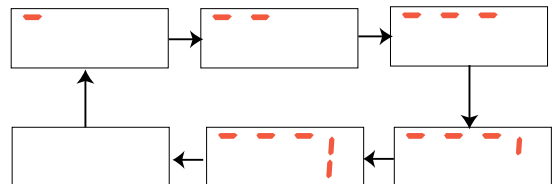

※ Quality of water remaining in system deteriorates if sample is not taken within a certain timeframe. While confirming quality in the display, draw sample until water purity improves.

② Pressing **PUSH** once more stops dispensing ion exchange water sample.

- “In-operation” lamp goes out.
- Sample dispensing progress stops showing in information display.

※ Sample may take a moment to begin dispensing from newly purchased unit or from unit on which a wear item has just been replaced, due to air in the system.

4. OPERATION PROCEDURE

Water Quality Index

Changing water quality index

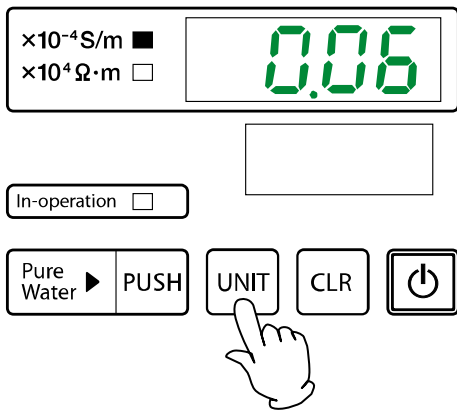

The water quality index may be changed by pressing **UNIT**.

- Conductivity reading



- Resistivity reading



※ Index conversion formula is shown below:

$$\text{Conductivity (S/m)} = \frac{1}{\text{Resistivity } (\Omega \cdot \text{m})}$$

$$\text{Resistivity } (\Omega \cdot \text{m}) = \frac{1}{\text{Conductivity (S/m)}}$$

See "How conductivity/resistivity relates to water purity" (P.27) for details.

Reverse Osmosis (RO) Membrane Flush

If ELB is ON, the RO membrane flush function automatically begins six hours after last sample draw or 24 hours after last system flush.

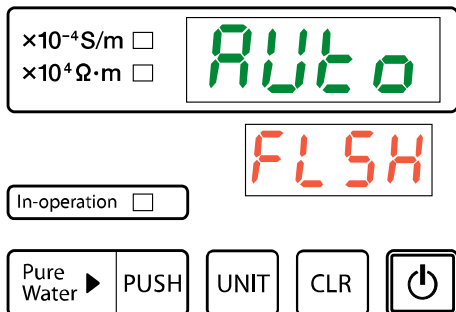

- Control panel displays will appear as shown on the left, during RO membrane flush.

- Flush duration is about one minute.

※ Samples may be taken during RO membrane flush and resumes automatically when sample is finished dispensing.

4. OPERATION PROCEDURE

Water Purity Assessment Process

Electronic conductivity measurement and display

The water conductivity meter on the control panel displays the conductivity at the outlets of the ion-exchange resin cartridge and at the distilled water condenser. The value displayed can be used as an indicator for replacing the ion-exchange resin cartridge. Conductivity value is valid only when the electrode is fully moistened with water, or when pure water is flowing. Proper value is not displayed in the following instances due to dry electrodes or air bubbles.

1. At beginning of an operation and when operation is paused
2. Just after pre-process cartridge or ion-exchange resin cartridge replacement

How conductivity/resistivity relates to water purity

- Electronic conductivity is shown as a value to indicate how easily electricity flows. In water, electricity flows more easily in higher electrolyte (electrically charged ions from impurities) concentrations. The higher the concentration of electrolytes, the greater the conductive value. The lower the concentration of electrolytes, the smaller the value.
- Accordingly, the smaller the electronic conductivity value, the more pure the water. Here, the electronic conductivity value indicates electrolyte content only, and does not consider the presence of non-conductive substances (organic and colloid substances, soluble gases, and microorganisms). This value is intended only as a single-tier indicator for showing water purity level, and is not all-encompassing.
- Resistivity is based on the same content as electric conductivity. Resistivity, however, is inversely related to electronic conductivity, so as value decreases, purity improves.
- Resistivity is obtained from electronic conductivity based on the following, where specific resistivity is R and electronic conductivity is ρ :

$$R[\Omega \cdot m] = \frac{1}{\rho [S/m]} \quad \text{or} \quad R[x10^4 \Omega \cdot m] = \frac{1}{\rho [x10^{-4} S/m]}$$

Therefore, the theoretical value of absolute pure water is as follows:

$$R = 18.2 \times 10^4 \Omega \cdot m \quad (18.2 M\Omega \cdot cm) \quad 25^\circ C$$

$$\rho = 0.055 \times 10^{-4} S/m \quad (0.055 \mu S/cm) \quad 25^\circ C$$

Ion exchange water quality

Ion exchange resin removes virtually all electrolytes from water so that water with the lowest electronic conductivity is obtained. Non-electrolytes, however, cannot be removed at this stage. In addition, water purity degrades slightly, immediately after ion exchange resin cartridge replacement and when water supply resumes following a pause in flow.

Reverse osmosis (RO) membrane water quality

The reverse osmosis (RO) membrane removes virtually all fine particles - electrolytes and non-electrolytes from water. Keep in mind, however, that it cannot remove ultra-fine particles which are smaller than the porous diameter of the membrane. Additionally, purity degrades slightly, just after RO membrane replacement and when water supply resumes following a pause in flow.

4. OPERATION PROCEDURE

Water Quality Characteristics Data (reference)

Useful lifespan of ion exchange resin cartridge (reference)

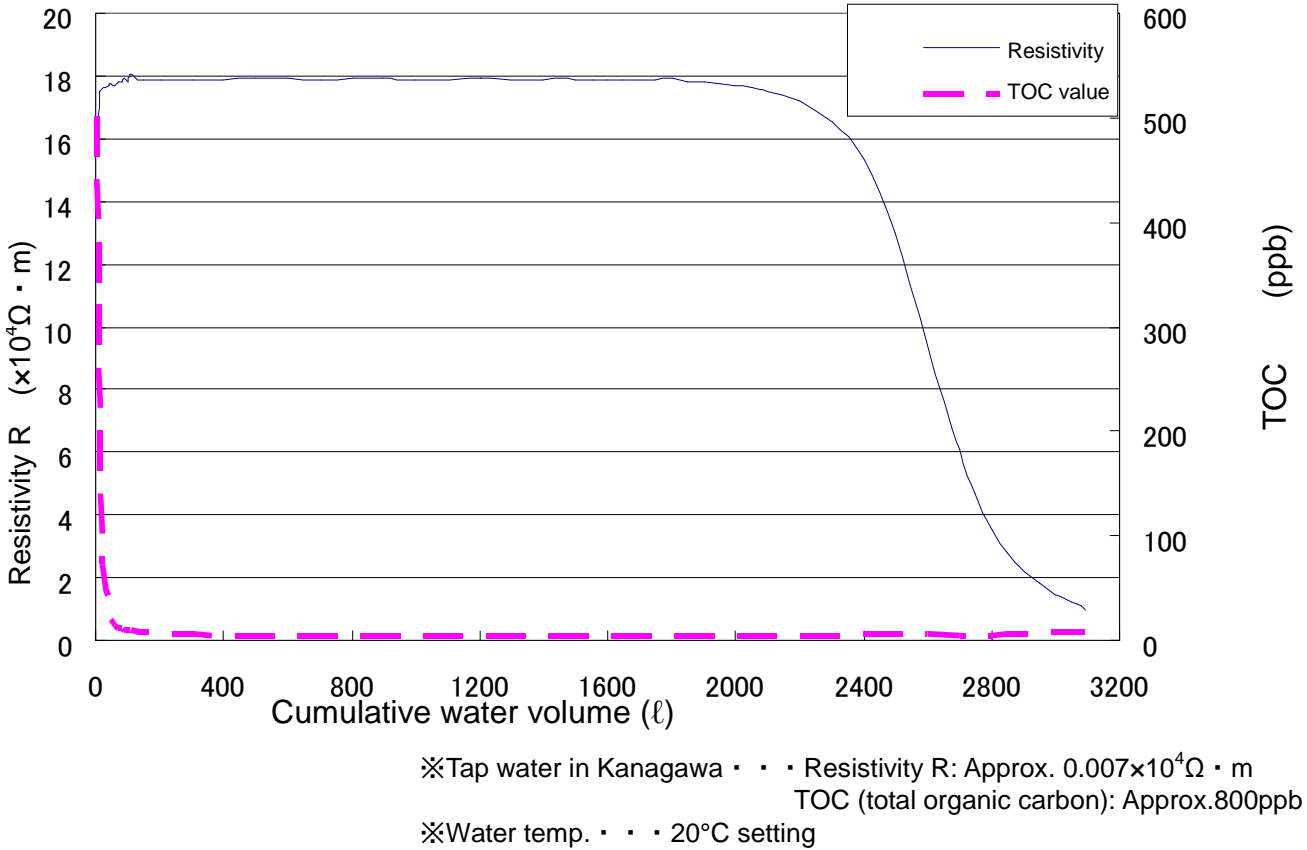

Initial water quality characteristics following ion exchange resin cartridge replacement (reference)

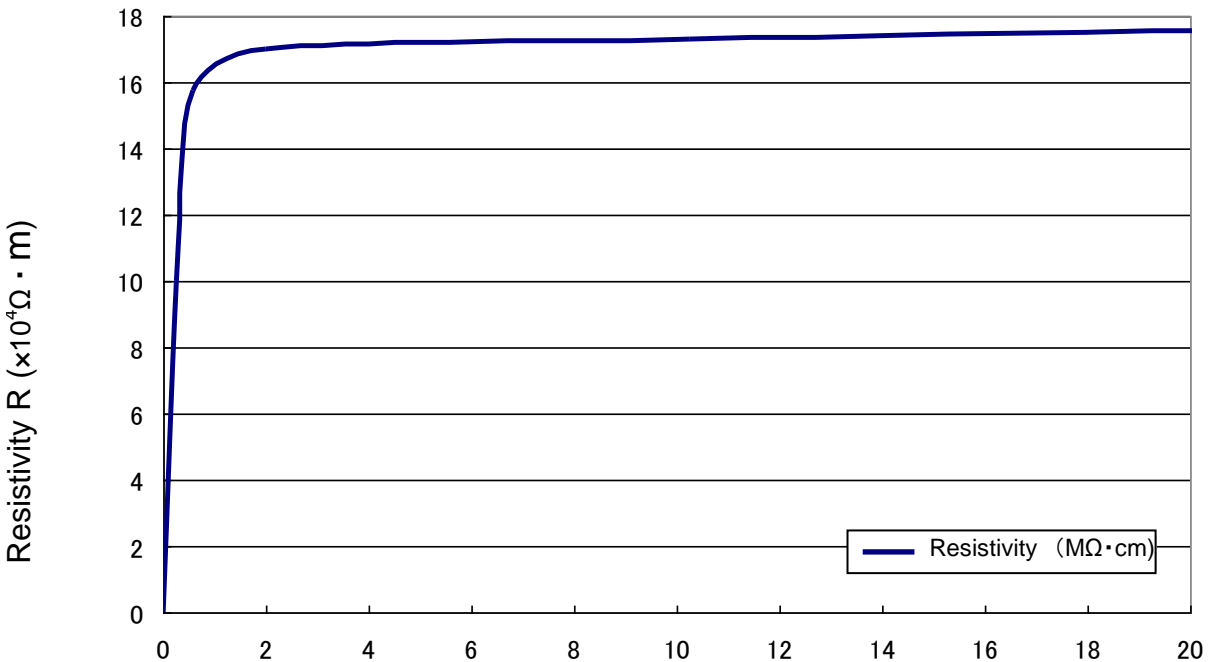

Water sampled has the transient characteristic shown above, immediately following ion exchange cartridge replacement, where several minutes are necessary for water quality to stabilize. Approximately 4ℓ water need to be discarded immediately following ion exchange cartridge replacement. Above information varies with base water quality and cartridge used. Use only as a reference.

4. OPERATION PROCEDURE

Water Sample Size Data Based On Water Temperature (reference)

Water temperature in samples range from 10 to 30°C. Samples dispense slower at colder temperatures due to reduced RO membrane transmission pressure at 10°C compared to 30°C. Actual water sample volume may deviate slightly from graph below, depending on unit calibration and RO membrane cartridge used.

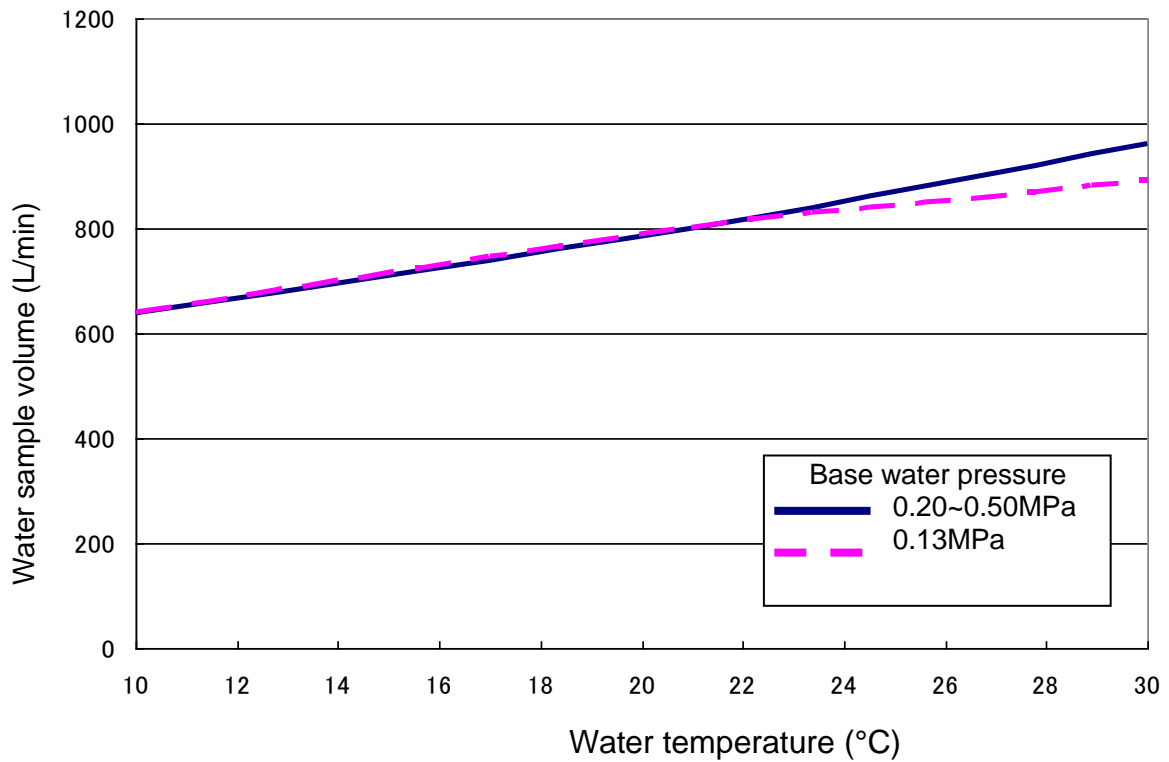

- ※Pressure calibration valve : 0.6MPa
- ※Membrane filter used

5. OPTIONAL ITEMS & MODIFICATIONS

Optional Components

Item name	Product code	Specification	Description
Water sampling stand (supplied in connection kit) (OWL40)	253266		Stand (included in connection kit) allows samples to be taken from a location apart from main unit. Membrane filter is installed on stand and a 3m tube is run from membrane filter port on main unit to membrane filter on stand. Stand should be placed on a table.
Water supply port unit (OWH10)	253686		Optional unit designed for use in the absence of a sink under the water line supplying base water. A water tap/faucet must be installed on water supply line.
Water supply port coupler (OWG32)	253764	Screw-in type	See "List of connection patterns with the water supply port" (P.32) for application details.
Water supply port coupler joint A (OWG34)	253765	For water pipe G1/2	
Water supply port coupler joint B (OWG36)	253766	For water pipe G3/4	
Water supply port coupler joint C (OWG38)	253767	For chemical faucet W26	
Water supply port coupler joint D (OWG40)	253768	For chemical faucet W30	
Water supply port coupler joint E (OWG46)	253771	For chemical faucet W24	
Remote water sampling function Connection terminal only (OWE12) ※ 1 ※ 2	253279		
Remote water sampling function With connection terminal + sampling foot switch (OWE14) ※1	253280		Optional footswitch allows samples to be taken hands-free. Most beneficial when used in conjunction with supplied water sampling stand. Must be specified when ordering main unit.
External alarm output terminal (OWE16) ※1	253278		Optional function generates an alarm signal when a leak and other malfunctions/errors occur or when wear items need replacement. This function can be linked to a pilot light, buzzer or other device to which a signal can be sent. Must be specified when ordering main unit.
MIZU guard	254199		Optional leak sensor designed to encircle water purifiers, MIZU guard detects leaks on/in unit and stops them via a motorized valve, which shuts off water supply.

※1 Option/function which must be specified when ordering unit.

※2 MIZU guard (product code : 254199) is recommended for added safety in remote installations.

5. OPTIONAL ITEMS & MODIFICATIONS

Optional Power Cable Accessories





Item name	Product code	Other information
Power cable PSE/UL standard TYPE A (ORE12) ※1	255410	Optional power cable with plug meeting Electrical Appliances and Material Safety Act, UL standard and CSA. Plug type : KP300C Cable type : Common for VCTF/SJT3/14AWG Socket type : KS-16F Ratings : 15A-125V Total length : 2m *DO NOT use this power cable with any electronic devices other than those supported and specified herein.
Power cable CEE standard TYPE S (ORE14) ※2	255411	Optional power cable with plug meeting CEE standard. Plug type : CEE7 (S TYPE) Cable type : H05VV-F/3 × 0.75mm ² Socket type : IEC60320 (Former IEC320) C13 Ratings : 10A-250V Total length : 1.8m *DO NOT use this power cable with any electronic devices other than those supported and specified herein.
Power cable BS standard TYPE BF (ORE16) ※2	255412	Optional power cable with plug meeting BS standard. Plug type : BS1363 (BF TYPE) Cable type : H05VV-F/3 × 1.0mm ² Socket type : IEC60320 (Former IEC320) C13 Ratings : 10A-250V Total length : 2m *DO NOT use this power cable with any electronic devices other than those supported and specified herein.
Power cable AS standard TYPE O (ORE18) ※2	255413	Optional power cable with plug meeting AS standard. Plug type : AS (O type) Cable type : GTSA/3 × 1.0mm ² Socket type : IEC60320 (Former IEC320) C13 Ratings : 10A-250V Total length : 2m *DO NOT use this power cable with any electronic devices other than those supported and specified herein.
4m power cable (OWL52)	253273	Optional power cable with plug meeting PSE. Designed to be used when the length of supplied power cable is insufficient. Ratings : 7A-125V (700W) Total length : 4m *DO NOT use this power cable with any electronic devices other than those supported and specified herein.

※1 Standard power cable supplied with unit.

※2 Is not certified by the Electrical Appliances and Material Safety Act. Use in Japan is prohibited.

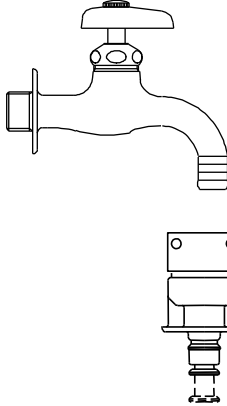
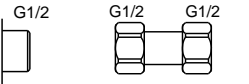
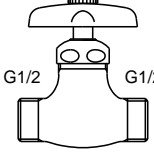
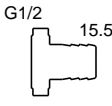
5. OPTIONAL ITEMS & MODIFICATIONS

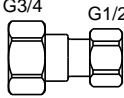
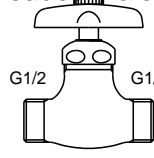
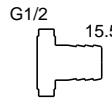
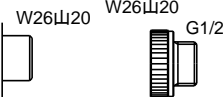
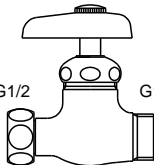
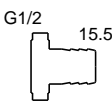
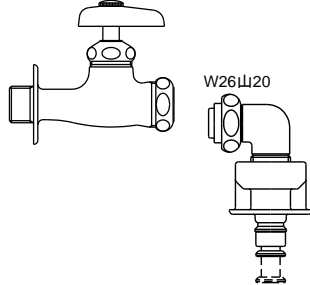
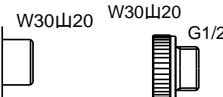
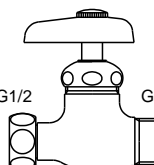
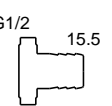
Optional Water Tap Supplies

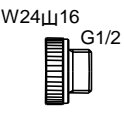
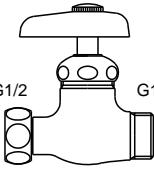
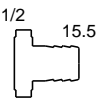
Table of connection combinations for water supply				
<p>Cap for standard water supply hose (with stopper) Connection for chemical tap (hose connection tap)</p>	<p>Water supply port coupler joint A (OWG34) water pipe connection using G1/2 threaded male coupler</p>			
				
	<p>Double nut union joint</p>	<p>Double external thread valve</p>	<p>Hose coupler</p>	
	<p>Water supply port coupler joint B (OWG36) Water pipe connection using G3/4 threaded male coupler</p>			
				
	<p>Double nut union joint</p>	<p>Double external thread valve</p>	<p>Hose coupler</p>	
	<p>Water supply port coupler joint C (OWG38) For W26 type chemical tap connection</p>			
<p>Water supply port coupler (OWG32) (threaded type · with stopper) Universal faucet outlet or swivel faucet outlet as removed for connection</p>				
	<p>Outlet (small)</p>	<p>Single-nut valve</p>	<p>Hose coupler</p>	
	<p>Water supply port coupler joint D (OWG40) For W30 type chemical tap connection</p>			
				
	<p>Outlet (large)</p>	<p>Single-nut valve</p>	<p>Hose coupler</p>	
	<p>Water supply port coupler coupling E (OWG46) For TOTO W24 type chemical tap connection</p>			
				
	<p>Conversion adapter</p>	<p>Single-nut valve</p>	<p>Hose coupler</p>	

5. OPTIONAL ITEMS & MODIFICATIONS

Optional Remote Sampling Terminal

The remote sampling terminal allows sampling with an input device from a remote location.

<p>Connection terminals (Terminal block screw size : M4)</p> <div style="text-align: center;"> <p>ALARM (output) REMOTE (input)</p> </div> <p>Example: Connect and use a switch.</p>	<p>Connect a switch or other input device to the remote sampling input terminals, located on right panel of main unit.</p> <p>Terminal block: Input contact: Non-voltage REMOTE input terminal</p> <ul style="list-style-type: none"> Remote sampling procedure: Sample is dispensed when contacts (circuit) are closed by switch or other device. Sample stops being dispensed when contacts are opened. <p>※ Do not apply voltage to the remote sampling input terminal. Unit malfunction may result. PUSH key is disabled during remote sampling.</p> <p>※ MIZU guard (product code : 254199) is recommended for added safety in remote installations.</p>
--	--

Optional Remote Alert Terminal

The external alarm function generates an alarm signal when unit errors occur or when wear items need replacement.

<p>Connection terminals (Terminal block screw size : M4)</p> <div style="text-align: center;"> <p>ALARM REMOTE</p> </div> <p>Load power supply Connection load</p> <p>Connection load example: Connect alarm lamp or alert buzzer..</p>	<p>Connect pilot light or other alert devices to external alarm output terminals, located on right panel of main unit.</p> <p>Terminal block : ALARM Output circuit : Relay a-contact (Normal Open)</p> <p>Contact capacity : AC250V 1A (Resistance load) DC30V 1A (Resistance load)</p> <ul style="list-style-type: none"> Relay contact closes when alarm signal is generated. External alarm signal will continue to be generated, even if alarm is cancelled. All external alarm signals, excluding those for leaks, stop once power key is turned OFF.
--	---

6. MAINTENANCE PROCEDURES

Maintenance Guide

Maintenance schedule (conduct daily general inspection for optimal performance)

Maintenance/inspection items	Interval	Additional information
Ion exchange resin cartridge replacement *1 (See P.11)	When CPC appears in information display	Continue drawing samples until water quality improves and CPC notification clears. (automatic recovery) An alert can be manually cleared by pressing and holding CLR .
	Other indicators: Conductivity reading of $1 \times 10^{-4} \text{S/m}$ or higher. Resistivity reading of $1 \times 10^4 \Omega \cdot \text{m}$ or lower * Processing capacity: Approx. 3,000ℓ	
Reverse osmosis (RO) membrane replacement *2 (See P.35)	When RO-C appears in information display	Notification can be cleared by pressing and holding CLR , following replacement. (See P. Error! Bookmark not defined.) Be sure to run initial wash and to adjust pressure calibration valve after replacing RO membrane (See pgs.16 & 17).
	Appears when cumulative life reaches two years * Processing capacity: Approx. 20,000ℓ	
Pre-process cartridge replacement *2 (See P.12)	When PBF appears in information display	Notification can be cleared by pressing and holding CLR , following replacement (See P. Error! Bookmark not defined.).
	* Processing capacity: Approx. 5,000ℓ	
Membrane filter replacement (See P.13) *2	When F.L.E appears in information display	Notification can be cleared by pressing and holding CLR , following replacement (See P. Error! Bookmark not defined.).
	* Processing capacity: Approx. 3,000ℓ Other indicators: Replace when dispensing rate drops to 0.5L/min or less , even if F.L.E does not appear in display.	
Two or more notifications occur at once	Conduct maintenance for all items.	Replace relevant wear items (See P. Error! Bookmark not defined.).
Water supply hose filter cleaning (See P. Error! Bookmark not defined.)	Every 6 months	Clean earlier if base water quality is degraded.
Hose replacement	Every 2 years	inspect for water leaks at least once a month.
Pressurization pump replacement	Every 2 years	Replace every 2 years.
Solenoid valve and pressure reduction valve replacement	Every 5 years	Replace every 5 years.
ELB inspection (See P.38)	Every month	Inspect once a month.

*1 Unit automatically displays replacement notification for this wear item based on water quality.

*2 Unit automatically displays replacement notification for this wear item based on sample draw time, beginning when CLR was last pressed to reset notification.

6. MAINTENANCE PROCEDURES

Ion Exchange Resin Cartridge Replacement

For replacement procedure, see “Install the ion exchange resin cartridge” (P.11). Notification alarm will automatically reset once water quality improves, following cartridge replacement.

- Degraded water quality and processing capacity will be exhibited from cartridges stored for an extended time period. Discretion is therefore advised in preparing spare cartridges. Cartridge shelf life is approximately 4 months.
- Spent cartridges should be discarded as non-combustible material or returned to Yamato (applicable in Japan only). Use the mailing label supplied with cartridge for returns. Yamato Scientific promotes collection and recycling for preservation of the environment.
- Following cartridge replacement, discard the first 4ℓ of water dispensed to purge system of air and initial impurities.

Pre-process Cartridge Replacement

For replacement procedure, see “8. Install the pre-process cartridge” (P.12). To reset notifications/alerts, see “How to reset after replacement of consumable parts” (P.36).

- Ion exchange resin cartridge life will shorten if unit is used without replacing the pre-process cartridge at specified interval.
- Spent cartridges should be discarded as non-combustible material or returned to Yamato (applicable in Japan only). Use the mailing label supplied with cartridge for returns. Yamato Scientific promotes collection and recycling for preservation of the environment.

Reverse Osmosis (RO) Membrane Replacement

To replace, see “13. Install the reverse osmosis (RO) membrane.

To reset notifications alerts, see “Wear Item Replacement Alert Reset” (P.36). Running Initial wash and adjusting the pressure calibration valve must be done after replacing RO membrane. For initial wash pressure calibration procedures, see “Run initial wash for reverse osmosis membrane” (P.16) and “15. Calibrate pressure for reverse osmosis membrane.

(P.17).

- Ion exchange resin cartridge life is shortened and specified water quality and/or sample size will not be accurate if RO membrane is not replaced at specified interval.
- Spent cartridges should be discarded as non-combustible material.

6. MAINTENANCE PROCEDURES

Wear Item Replacement Alert Reset

The useful life of each replaceable cartridge is determined by cumulative water volume it can reliably filter within a predicted timeframe.*1 The WE200 unit counts the cumulative water volume filter time (in hours) for each cartridge and generates notifications to the user when replacement is needed (See display descriptions on P.41). When replacing filter cartridges, reset cumulative water volume hours using the procedures outlined below.

Resetting replacement notifications/alerts



FILL

In-operation

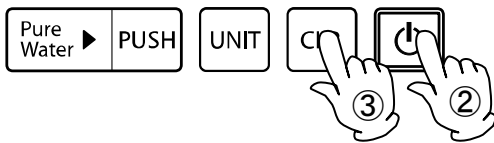

① Turn the ELB "ON (|)".

② Press **POWER**.

• For single item alert

③ Pressing and holding **CLR** sounds an acceptance tone and resets the notification so that normal operation may be resumed.

• For multiple item alert

③ Pressing and holding **CLR** sounds acceptance tone and resets the **CPC** notification.

④ Pressing and holding **CLR** again sounds acceptance tone and resets the **ro-c** notification.

⑤ Repeat to clear any other alert items so that normal operation may be resumed.

* Reset the alerts ONLY after replacing items for which alerts were generated.

* When multiple replacement alerts are generated, reset order is as follows. Replace all items and clear all alerts before attempting to resume operation.

Reset order: **CPC** → **ro-c** → **PBF** → **FILL**

* If premature replacement notifications/alerts are suspected, call for service.

*1 Useful life of ion exchange resin cartridge is determined by water quality.

6. MAINTENANCE PROCEDURES

Accumulated Volume Hour Reset

Replacing items and resetting volume hours before notification is generated

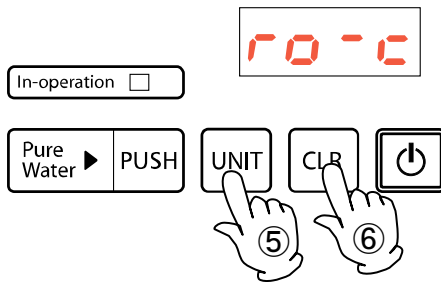
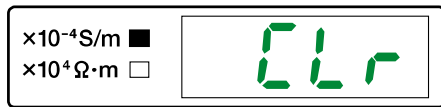
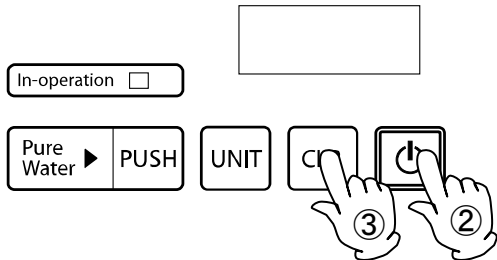
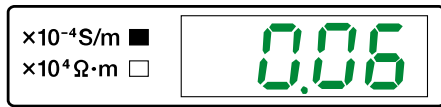

- ① Turn the ELB "ON(|)".
- ② Press **POWER**.
- ③ Pressing and holding **CLR** brings up **CLR** in water quality display and unit enters wear item reset mode.
- ④ Each time **UNIT** is pressed, indicators can be toggled through in the information display as follows.

The sequence of indicators shown is: **ro-c** → **FILL** → **PBF**.
- ⑤ Select item to be replaced, press and hold **CLR** (acceptance tone will sound) to reset cumulated water volume hours for that item. Normal operation can be resumed. To exit reset mode without resetting, press and hold **UNIT** to resume normal operation.

- * Reset the volume hours ONLY after item has been replaced. Be advised that cumulated volume hours cannot be restored once they have been reset.
- * Use the above procedure for replacing wear items which show time-related deterioration before a replacement notification is generated.

Cartridge/filter replacement, according to the following intervals is recommended to maintain consistent water quality, regardless of replacement alerts.

- Membrane filter Yearly
- pre-process cartridge Yearly
- ion exchange resin (CPC-T) cartridge Yearly
- Reverse Osmosis (RO) membrane Every 2 years

6. MAINTENANCE PROCEDURES

Water Supply Hose Filter Maintenance

1. Turn ELB off (O). Turn water supply tap off. Slide the sleeve in direction of arrow, and remove water supply hose from the connection port.
 2. Remove plug ② from ring ① while turning.
 3. Clean filter ⑦ seal filter with water.
 4. Scrub filter with brush or other appropriate cleaning utensil until thoroughly cleaned.
 5. Reassemble by reversing the above procedure
- * Clean the water supply hose filter approximately once every six months.

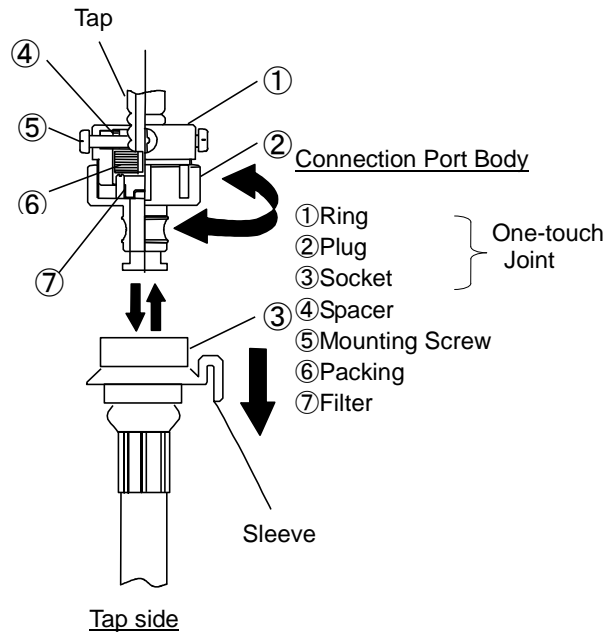

ELB Function Check

- Conduct this test with power cable connected.
- Turn ELB "ON (|)".
- Press ELB test button with a fine-tipped object, such as the tip of a ball point pen, and confirm that the ELB turns off, indicating normal operation.

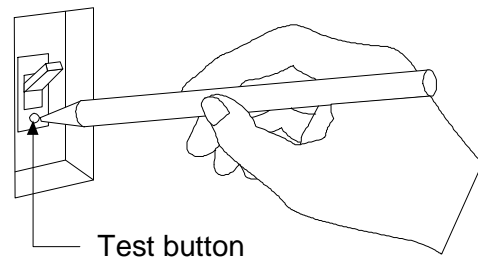

7. EXTENDED STORAGE & DISPOSAL



1. Equipment disposal



- Discard as bulky waste.
- Do not leave unit unattended, or in a location where children may have access.

2. Maintaining water quality and RO membrane stability



- As a rule, see that the following elements are maintained to keep automatic flush function enabled.
 1. Leave ELB "ON (|)".
 - * **POWER** key may be kept ON or OFF.
 2. Keep water supply tap open and keep drain unobstructed.

3. Resuming operation after extended storage



- When possible, leave ELB "ON (|)" and water tap open, even if unit will be out of service for an extended period of time (7 days or longer).
Close water tap if circumstance necessitates turning OFF the ELB. If unit is not operated for some time, the quality of water remaining in the system will deteriorate and a water quality error (CPC display) may be displayed when resuming operation. Press the "PUSH" key to completely clear the sampling path, and wait for the CPC display to clear before proceeding further.
- If adequate performance cannot be restored after resetting ELB and thoroughly clearing the sampling path, replace applicable wear items.

7. EXTENDED STORAGE & DISPOSAL

Disposal Considerations

Dispose of or recycle this unit in a responsible and environmentally friendly manner. Yamato Scientific Co., Ltd. strongly recommends disassembling unit, as far as is possible, in order to separate parts and recycle them in contribution to preserving the global environment.

Major components and materials, comprising WE200 units are listed in the table below:

Names of major components	Material
Major component breakdown	
External casing	Iron and galvanized steel, melamine resin baked finish
External casing back plate	Iron and galvanized steel, melamine resin baked finish
Door	ABS resin
Door backing plate	Stainless steel SUS304
Installation fixtures (painted)	Iron and galvanized steel, melamine resin baked finish
Installation fixtures (unpainted)	Stainless steel SUS304
Hinges	Stainless steel SUS
Rubber feet	Synthesized rubber
Nameplate	Polyethylene terephthalate (PET)
Major components of water circulation system	
Water supply port	Brass
Water quality sensor	Polypropylene Other composites
Membrane filter	Polycarbonate Other composites
Water circulation components	
pre-process cartridge	Polystyrene Other composites
ion exchange resin cartridge	Polystyrene Other composites
Reverse Osmosis (RO) membrane	Polyamide Other composites
Resin drum casing	Polypropylene
Water quality sensor electrode	Titanium
Pressure reduction valve (metal parts)	Body: brass







Major part name	Material
Major components of plumbing system	
Water supply hose	Vinyl chloride
Hose pipe (white)	Polyethylene
Drain hose	Polyolefin
Quick coupler (resin)	Polypropylene
Quick coupler (metal)	Brass Stainless-steel
Major components of electrical system	
Water supply solenoid valve	Body: brass Other composites
Water sampling solenoid valve	Body: PDM Other composites
Concentrated water drain solenoid valve	Body: Stainless-steel Other composites
Filtered water drain solenoid valve	Body: Stainless-steel Other composites
Power cable, wire material, other	Synthesized rubber sheathed and resin sheathed wire materials and substrates

8. TROUBLESHOOTING

Error Codes





Error Code Troubleshooting

When an error appears in information display, record details of error, turn ELB "OFF (o)" immediately and shut off water supply tap. If an abnormality occurs, component replacement or unit inspection may be necessary. Contact a local dealer or sales office for assistance. Be prepared to give unit serial number, specific error details and background when making service calls.

Error indications	Error code	Possible causes	Possible solutions
Water quality sensor error		<ul style="list-style-type: none"> Water quality sensor's temperature compensator is disconnected, severed or has short-circuited Water temperature is temporarily outside measurable range (0°C~100°C). 	<ul style="list-style-type: none"> Reset ELB. If error persists, call for service.
CPU board error		<ul style="list-style-type: none"> Memory element settings cannot be read correctly Settings are incorrect. A/D circuit error has been detected. 	<ul style="list-style-type: none"> Reset ELB. If error persists, call for service.
Upper limit pressure error		<ul style="list-style-type: none"> Supply water temperature is less than 10°C Reverse Osmosis (RO) membrane is clogged Water sampling solenoid valve malfunction has been detected Pressure reduction valve malfunction has been detected 	<ul style="list-style-type: none"> Confirm that base water temperature is within proper working range of 10°C~30°C. Reset ELB. If error persists, call for service.
Lower limit pressure error		<ul style="list-style-type: none"> Pressure calibration valve has been improperly adjusted Reverse osmosis (RO) membrane is damaged Defect in pump has been detected Drain solenoid valve malfunction has been detected 	<ul style="list-style-type: none"> Inspect unit for leaks. If leak is found in plumbing system, call for service. Reset ELB. If error persists, call for service.
Water leak error		<ul style="list-style-type: none"> Water has dripped on leak sensor 	<ul style="list-style-type: none"> If water leaks onto leak sensor during replacement of filter cartridges, reset ELB and allow leak sensor to dry. (See P.Error! Bookmark not defined.) If leak is found in plumbing system, call for service.
Solenoid valve error		<ul style="list-style-type: none"> Flow rate sensor is not properly detecting the specified working flow rate Water supply solenoid valve malfunction has been detected Pre-process cartridge is clogged 	<ul style="list-style-type: none"> Install a wider-mouthed water tap outlet. If error persists after modification, call for service.

8. TROUBLESHOOTING

Error Codes

Other indications	Error code	Possible causes	Solution
Out of measurable range		<p>Measurable upper limit of water quality range has been exceeded</p> <ul style="list-style-type: none"> • Conductivity $<0.05 \times 10^{-4} \text{ S/m}$ • Resistivity $>20 \times 10^4 \Omega \cdot \text{m}$ 	<ul style="list-style-type: none"> • Press [PUSH] to begin drawing sample. If numeric values fail to appear during or after taking sample, call for service.
		<p>Measurable lower limit of water quality range has been exceeded</p> <ul style="list-style-type: none"> • Conductivity $>10 \times 10^{-4} \text{ S/m}$ • Resistivity $<0.1 \times 10^4 \Omega \cdot \text{m}$ 	<ul style="list-style-type: none"> • Replace the ion exchange resin cartridge (See P.11). If numeric values fail to appear after replacement, call for service.
Water supply error		<ul style="list-style-type: none"> • Base water pressure is too low (at or below 0.13MPa) or water supply has been cut off 	<ul style="list-style-type: none"> • Confirm that water supply is on and that water supply tap is open. • Install a wider-mouthed water tap outlet. If the error persists after tap modification, call for service.
Pressurization pump error		<ul style="list-style-type: none"> • Working flow rate has dropped below specified value • Pre-process cartridge is clogged • Reverse osmosis (RO) membrane is clogged 	<ul style="list-style-type: none"> • Reset ELB. If error persists, call for service.

8. TROUBLESHOOTING

Malfunctions

More on leak detection **E-31** error

●Confirmation

1. Confirm that the water supply connection coupler and quick couplers on ion exchange resin cartridge, pre-process cartridge and the Reverse Osmosis (RO) membrane are securely connected.

* If leaks are discovered coming from unit plumbing system, turn ELB off immediately, shut off main water supply tap and contact local dealer or sales office for assistance.

2. Confirm that water has not dripped on leak sensor while replacing a cartridge or other wear item.

●Solution procedures

(1) Turn the ELB "OFF(O)".

(2) Isolate leak. Leak sensors are located at the two positions shown below:

- Front side - visible when the door is opened.
- Rear of main unit

(3) Remove leak sensor from main unit, thoroughly wipe all moisture from electrode and from interior of unit. Allow them to dry completely.

(4) When dry, be sure to replace leak sensor(s) in original position.

(5) Replace door and close.

(6) Turn ELB "ON (|)" and press the POWER key to resume normal operation.

* ALWAYS shut main water supply tap off BEFORE attempting to disassemble system plumbing (i.e. to repair a leak).

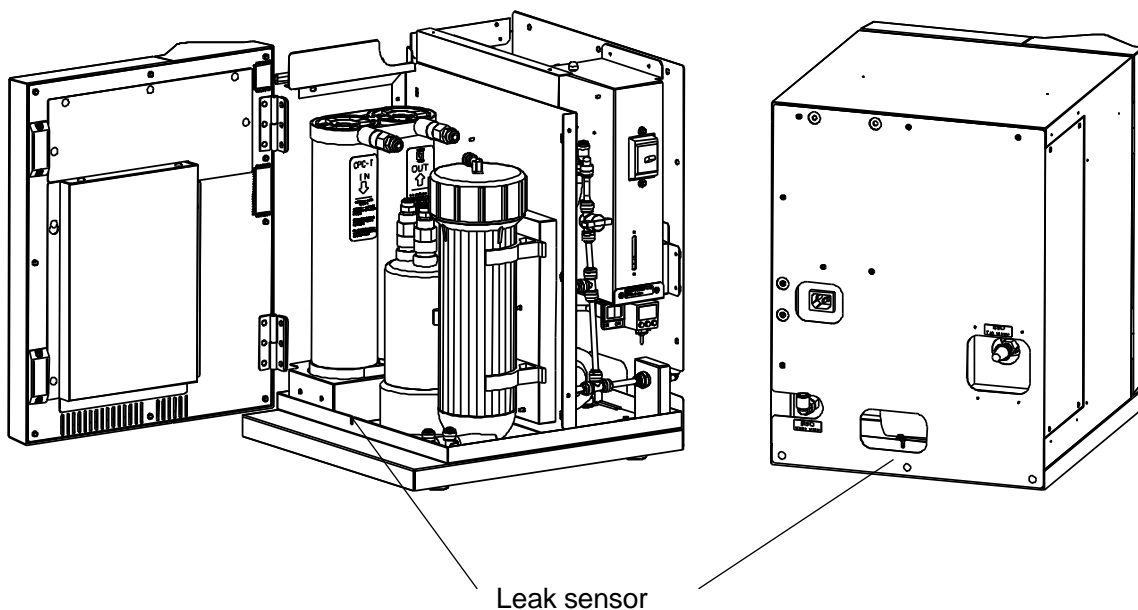

8. TROUBLESHOOTING

Malfunctions

Symptom	Possibility of a malfunction	Countermeasures
No power	● Power cable not connected securely	Reinsert the power cable Confirm connection
	● Facility power supply is defective or does not properly meet unit rating	Confirm facility power supply is single phase AC100V~240V
No (or poor) water flow	● Water tap outlet opening too small	Use wider-mouthed tap outlet
	● Insufficient water supply pressure or water supply has been cut off	Confirm that water supply tap is turned on
	● Water supply hose not connected securely	Reconnect water supply hose Confirm connection (See pgs. 9 & 10)
Water sample cannot be drawn	● Pre-process cartridge, ion exchange resin cartridge or membrane filter is clogged	Confirm whether items have gone without being replaced for longer than designated
	● Water supply solenoid valve or water sampling solenoid valve is defective	Replace
Water sample size is too small	● Water temperature is too low (<9°C)	Operate unit within specified water supply temperature range (10°C ~ 30°C)
	● Reverse Osmosis (RO) membrane is clogged	Replace
	● Initial wash switch is ON	Turn initial wash switch OFF.
Water sample size is too large	● Water temperature is too high (>30°C)	Operate unit within specified water supply temperature range (10°C ~ 30°C)
	● Reverse Osmosis (RO) membrane is damaged	Replace
Water quality is degraded	● Reverse Osmosis (RO) membrane has not had initial wash	Run initial wash for reverse osmosis (RO) membrane, if it has not been done yet (See P.15).
	● Ion exchange resin cartridge is deteriorated	Sample about 10ℓ If water quality does not improve, replace the ion exchange resin cartridge.
	● Air remaining in ion exchange resin cartridge	
	● Ion exchange resin cartridge has gone unused for an extended period of time	

9. SERVICE & REPAIR

Requests for Repair

When a problem occurs, terminate operation immediately, turn off main power switch (ELB) and disconnect power cable.

Contact a local dealer or Yamato sales office for assistance.

The following information is required for all repairs.

- Model name
- Serial Number
- Date (year/month/day) of purchase
- Description of problem in as much detail as possible

Refer to serial no. and rating sticker on unit.

See "Component Names and Functions" (P.18) for sticker location.

Guaranteed Supply Period for Repair Parts

Guaranteed maximum supply period for repair parts is 7 (seven) years from date of discontinuation for WE200 model. "Repair parts" is defined as components which, when installed, allow for continued unit operation.

10. SPECIFICATIONS

Model		WE200		
Performance	Water sample flow order	RO membrane→ion exchange→filtration		
	Water supply	Resin hose connected to tap water via quick coupler		
	Pure water sample	JIS K 0557 A4-equivalent		
	※1 Sample size and mode *2	0.5~1.0L/min · continuous		
Configuration	Pre-process cartridge	0.1μm hollow fiber + activated charcoal included (PWF-1)		
	Flow sensor	Open pulse signal (NPN) output		
	Reverse osmosis (RO) membrane pump	Pressurized water supplied to reverse osmosis (RO) membrane		
	Pressure gauge	Universal pressure switch for fluid		
	Reverse osmosis (RO) membrane	Thin membrane mix type		
	Ion exchange	2l ion exchange resin containing activated charcoal (CPC-T) 1		
	Water quality sensor	Electrode system		
	Final filtration	0.1μm Membrane filter		
Standards	Leak sensor	Parallel dual electrode system		
	Base water pressure range ※2	0.13~0.50MPa (1.3~4.9kgf/cm ²)		
	Base water temperature range	10°C~30°C		
	Safety device	Water cut-off error, Water quality sensor error, CPU board error, upper/lower limit pressure error, leak error, flow alarm/error, ELB		
	Maximum discharge	Approx.2l/min (during system flush)		
	Power supply *3	Rated voltage: single phase AC100-240V, Rated frequency: 50/60Hz		
	Outer dimensions *4 (W × D × H)	350mm × 430mm × 470mm		
	Water sampling port	250mm above floor		
Indications	Weight	Main body : Approx. 30kg (dry)		
	Water quality	7-segment LED display (Conductivity/Resistivity)		
	Other	Wear item replacement alert display (ion exchange resin, pre-process cartridge, reverse osmosis (RO) membrane, membrane filter), warning display (leak alert)		
Included accessories	Water supply hose (w/connection kit)	1		
	Power cord	1		
	Instruction manual	1 (this document)		
	ion exchange resin cartridge(CPC-T)	1		
	pre-process cartridge	1		
	Membrane filter	1		
	Seal tape	1		
Drain hose	3m × 1			
Wear items		Component	Model	Product code
		ion exchange resin cartridge	CPC-T	253256
		pre-process cartridge	PWF-1	253099
		reverse osmosis (RO) membrane cartridge set	RO-1S	253257
		Membrane filter (2 included)	MFRL727	9020010004
	Thread seal tape	---	F0260021	

※1 Performance data based on AC100 to 240V power supply, 23°C±5°C room temperature and 65%RH±20% humidity. Peripheral operating temperature range is 5°C to 35°C.

※2 Performance is guaranteed at 0.2 to 0.5MPa (2.0~.9kgf/cm²) base water pressure, at water temperature of 20°C. Water sample sizes vary with water temperature changes.

※3 100V power cord (with grounded 3-prong plug) is included. Use optional power cord for voltages other than AC100V.

※4 Protrusions excluded from standard dimensions.

11. WIRING DIAGRAM

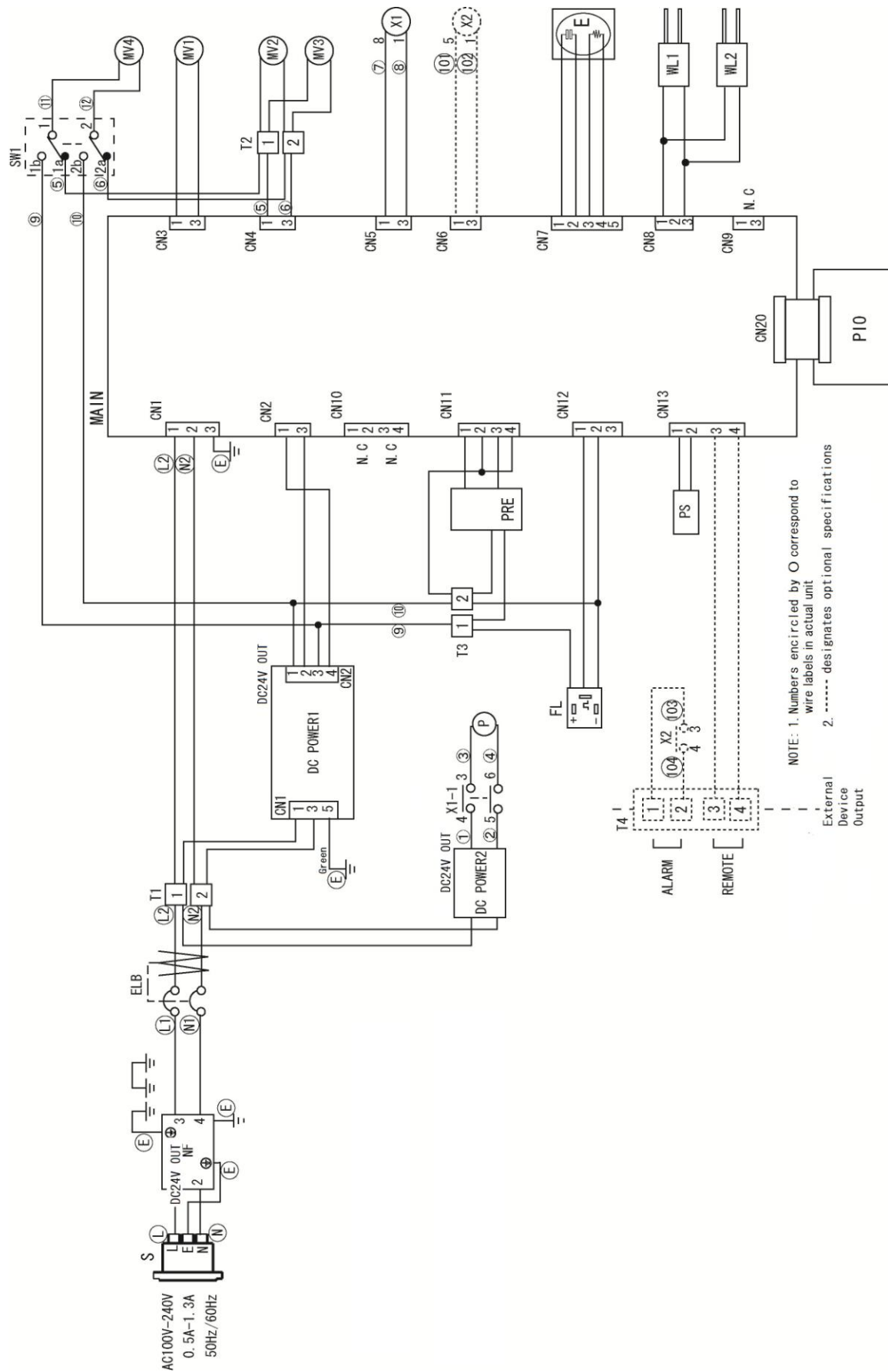

11. WIRING DIAGRAM

Wiring Diagram Glossary

• Standard components

Symbol	Part name	Symbol	Part name
S	Power outlet (AC250V, 15A)	MV1	Water supply solenoid valve (DC24V, N.C.)
ELB	Electric Leakage Breaker (AC100-240V,10A)	MV2	Water sampling solenoid valve (DC24V, N.C.)
NF	Noise filter (AC250V,3A)	MV3	Filtered water drain solenoid valve (DC24V, N.O.)
T1	Terminal block for wiring (AC250V, 20A)	MV4	Concentrated water drain solenoid valve (DC24V, N.O.)
T2	Terminal block for wiring (AC250V, 20A)	E	Water quality sensor
T3	Terminal block for wiring (AC250V, 20A)	WL1	Leak sensor 1
X1	Output relay for pressurization pump (DC24V)	WL2	Leak sensor 2
MAIN	Planar substrate (T00MA-Q)	PS	Pressure switch (AC250V, 3A)
PIO	Display substrate (T00DP)	P	Pressurization pump (DC24V)
DC POWER 1	DC power supply (DC output : 24V, 2.1A)	DC POWER2	DC power supply (DC output : 24V, 3.0A)
PRE	Pressure gauge (DC12-24V)	SW1	Initial wash select switch (DC30V,10A)

• Optional components

Symbol	Part name	Symbol	Part name
T4	Terminal block for auxiliary components (AC250V, 20A)	X2	External alarm output relay (DC24V)

12. WEAR ITEMS

Component name	Code No.	Specification	Manufacturer
Ion exchange resin cartridge	253256	CPC-T	Yamato
pre-process cartridge	253099	PUF-1	Yamato
reverse osmosis (RO) membrane	253257	RO-1S	Yamato
Membrane filter(2 included)	9020010004	MFRL727	Yamato
Plumbing hose	LT00036230	HW-TU-14 1/4*0.17	Yamato
Drain hose	3040036003	PL-4 8 × 10 Milk white	NITTA MOORE
Quick coupler (for ion exchange resin cartridge)	3140030008	QJ-22D	Wamoto
Pre-process coupler	LT00036217	TSF-2WR	JOPLAX
Water supply hose	LT00015141	With mesh and stopper	Iida Rubber

13. LIST OF HAZARDOUS SUBSTANCES



Never attempt to process explosives, flammables or any items which contain explosives or flammables

Explosive Substance	①Nitroglycol, Glycerine trinitrate, Cellulose Nitrate and other explosive nitrate esters
	②Trinitrobenzen, Trinitrotoluene, Picric Acid and other explosive nitro compounds
	③Acetyl Hydroperoxide, Methyl Ethyl Ketone Peroxide, Benzoyl Peroxide and other organic peroxides
	④Metallic Azide, including Sodium Azide, etc.
Explosive Substances	①Metal "Lithium" ②Metal "Potassium" ③Metal "Natrium" ④Yellow Phosphorus
	⑤Phosphorus Sulfide ⑥Red Phosphorus⑦Phosphorus Sulfide
	⑧Celluloids, Calcium Carbide (a.k.a, Carbide)⑨Lime Phosphide⑩Magnesium Powder
	⑪Aluminum Powder ⑫Metal Powder other than Magnesium and Aluminum Powder
	⑬Sodium Dithionous Acid (a.k.a., Hydrosulphite)
Oxidizing Substances	①Potassium Chlorate, Sodium Chlorate, Ammonium Chlorate, and other chlorates
	②Potassium Perchlorate, Sodium Perchlorate, Ammonium Perchlorate, and other perchlorates
	③Potassium Peroxide, Sodium Peroxide, Barium Peroxide, and other inorganic peroxides
	④Potassium Nitrate, Sodium Nitrate, Ammonium Nitrate, and other nitrates
	⑤Sodium Chlorite and other chlorites
	⑥Calcium Hypochlorite and other hypochlorites
Flammable Substances	①Ethyl Ether, Gasoline, Acetaldehyde, Propylene Chloride, Carbon Disulfide, and other substances with ignition point at a degree 30 or more degrees below zero.
	②n-hexane, Ethylene Oxide, Acetone, Benzene, Methyl Ethyl Ketone and other substances with ignition point between 30 degrees below zero and less than zero.
	③Methanol, Ethanol, Xylene, Pentyl n-acetate, (a.k.a.amyl n-acetate) and other substances with ignition point between zero and less than 30 degrees.
	④Kerosene, Light Oil, Terebinth Oil, Isopenthyl Alcohol(a.k.a. Isoamyl Alcohol), Acetic Acid and other substances with ignition point between 30 degrees and less than 65 degrees.
Combustible Gas	Hydrogen, Acetylene, Ethylene, Methane, Ethane, Propane, Butane and other gases combustible at 15°C at one air pressure.

Excerpt from Table 1, Hazardous Substances, in Cabinet Order from Occupational Safety and Health Law (substances related to Articles 1, 6, and 9)

14. SETUP CHECKLIST

* Setup WE200 units using the following procedure:

Model	Serial number	Installation Date	Installed by (company or personnel)	Installation approved by	Assessed by

No.	Item	Implementation Procedure	Section No. & Instruction manual reference page	Assessed by
-----	------	--------------------------	---	-------------

Specifications

1	Accessories	Confirm number of included accessory items	10. Specifications P.46	
2	Installation	<ul style="list-style-type: none"> Check site visually. Caution: check for hazards Prepare installation space. 	2. Pre-Operation Procedures P.5 <ul style="list-style-type: none"> At installation site . . . 	
		<ul style="list-style-type: none"> Measure line voltage (power distribution terminal, outlet, etc.) with voltmeter. Measure line voltage during operation. (Must meet required voltage rating) Caution: Confirm outlet rating or breaker power rating meet unit requirements. 	2. Pre-Operation Procedures P.5-6 10. Specifications P.46 <ul style="list-style-type: none"> Standard—Power supply 	
		Check base water	2. Pre-Operation Procedures P.8 <ul style="list-style-type: none"> Base water 	

Orientation

1	Operation	Explain function of each component as written in instruction manual	4. Operating procedure P.24-27 1. Safety Precautions P.1-4 List of dangerous substances 50	
2	Installation of RO membrane	Explanation of how to install the RO membrane and perform initial washing	2. Pre-Operation Procedures P.9-17 <ul style="list-style-type: none"> Installation 	
3	Error Codes	Explain error codes and reset procedures as written in instruction manual	8. Troubleshooting P.41-45 <ul style="list-style-type: none"> Service & Repair 	
4	Maintenance & Inspection	Explain of inspection and maintenance procedure as written in instruction manual	6. Maintenance Procedures P.34-38 <ul style="list-style-type: none"> Inspection & maintenance 	
5	Installation data entry Completion	<ul style="list-style-type: none"> Fill in installation date and name of installing personnel or company on unit "OK and Service Sticker" Explain how to contact technician 	9. Service & Repair P.45	

Limited Liability

Always operate equipment in strict compliance to the handling and operation procedures set forth by this instruction manual.

Yamato Scientific Co., Ltd. assumes no responsibility for malfunction, damage, injury or death, resulting from negligent equipment use.

Never attempt to disassemble, repair or perform any procedure on WE200 units which are not expressly mandated by this manual. Doing so may result in equipment malfunction, serious personal injury or death.

Notice

- **Instruction manual descriptions and specifications are subject to change without notice.**
- **Yamato Scientific Co., Ltd. will replace flawed instruction manuals (pages missing, pages out of order, etc.) upon request.**

Instruction Manual

Non-heating Water Purifier Pure Line®

WE200

First edition March 8, 2013

Last Revision August 2, 2013

YAMATO SCIENTIFIC RUSSIA, INC.

Russia, Moscow, st. Friedrich Engels, 46,
building 2

Tel : +7 495 740-68-71

E-mail: sales@yamatorussia.ru

<https://yamatorussia.ru/>